

LIFE OF CHRIST

VOLUME 1

PLEASE NOTE!

The visuals for this series can be purchased from most CEF offices and online shops. For a list of CEF offices and online shops in Europe, please visit www.teachkids.eu and click on "Locations".

Original text: Katherine Hershey
Revised by Lynne Herlein
and Lora Strong

Adapted for Europe: Jennifer Haaijer
(With additional ideas
from the original text)

Text published by: European CEF®
Kilchzimmer
4438 Langenbruck
Switzerland
www.cefeurope.com



Copyright © 1999, 2009 Child Evangelism Fellowship® Inc.
All rights reserved. Used by permission. May be reproduced
for personal, nonprofit and non-commercial uses only.
Visit www.teachkids.eu for full details of permission.

Table of contents

<i>Lesson</i>		<i>Page</i>
Introduction		3
Overview		6
Lesson 1	The annunciation	7
Lesson 2	The shepherds hear of the Saviour	15
Lesson 3	The wise men worship the King	25
Lesson 4	The Lord Jesus Christ as a child	33
Lesson 5	The Lord Jesus Christ in temptation	43
Lesson 6	The Lord Jesus calling disciples	53
Jesus Christ is God the Son (carry-over activity - lesson 1)		64
Jesus Christ is God the Son (carry-over activity for preschoolers - lesson 1)		65
The only Saviour from sin (central truth - lesson 2)		66
Jesus Christ was born King (central truth - lesson 3)		67
True worship (carry-over activity - lesson 3)		68
The Kingdom of Jesus (carry-over activity - lesson 3)		69
Jesus was tempted just as we are (central truth - lesson 5)		70
Using God's Word (carry-over activity - lesson 5)		71
Following Jesus (central truth - lesson 6)		72
Following Jesus (carry-over activity - lesson 6)		73
Summary of steps for counselling the child who wants to come to Christ		74

Introduction

Teaching Bible truths

Teaching the Word of God to children is one of the greatest privileges a believer can have. It brings with it a two-fold responsibility - to evangelise unsaved children and to edify the saved.

Unsaved children must be taught the message of salvation - a message about God, man's sin, the person and work of Jesus Christ, and the appropriation of salvation. Each of these areas of truth includes several or many wonderful doctrines, all of which we should teach to boys and girls.

God

Unless children are taught what God has revealed of Himself, they will formulate their own erroneous concepts. We must teach His holiness, greatness, love, sovereignty, wisdom, omniscience, omnipotence, etc.

Man's sin

Teach children that they are sinners by nature and action, that sin is disobedience to God's law, and that it brings separation from God.

The Lord Jesus Christ

He is the eternal Son of God who became man. He lived a sinless life, died a substitutionary death for sinners, rose, ascended and is exalted at God's right hand.

The appropriation of salvation

We must carefully teach children how they can be saved. Repentance and faith should be carefully explained and repeated.

Obviously, it is impossible to teach all of these truths in every lesson. Many children know little or nothing, so what we do include should be thoroughly taught. Teach truths which emerge from the narrative. Do not forget to use all of your programme to teach the children.

Saved children will benefit from this thorough teaching evangelism, but we must also teach them truths which will strengthen, help and guide them in their Christian lives. Endeavour, over a period of time, to teach them "all the counsel of God".

The lessons in "Life of Christ - Volume 1", cover the period from the annunciation to the beginning of the Lord Jesus Christ's public ministry. You have the opportunity, not only to recount exciting narrative, but also to teach vital truths about the Lord Jesus Christ. As you do so, pray that God the Holy Spirit will use His Word to bring children to know the One Who is the centre of each lesson.

Central truths

Each lesson includes the thorough teaching and application of a central truth. You will notice that the central truths are marked with a "U" or an "S" to show the kind of children the truth is applied to - unsaved or saved. This is also made clear in the text by using phrases such as, "If you have not trusted the Lord Jesus to forgive your sin ..." or, "Christian, you ...".

The application of the truth has been highlighted with a line beside the text. You may feel it necessary to adapt the applications to better suit the children you teach. For example, the application may use a boy's name, yet you have only girls present. It could be that the application given is more applicable to older children, while yours are very young. Make the changes you feel are necessary. The important thing is that the Word of God is applied to their lives.

Make yourself available for counselling

When you present the Gospel message, there will be children who will respond to it independently. They may or may not at a later date tell you that they have trusted the Lord Jesus Christ as Saviour. There will, however, be others who would like some help. They may have questions to ask; they may need help or encouragement in knowing what to say.

As you teach the saved children, there may be times when they would like advice in a difficult situation; they may need clarification on how a particular lesson applies to their daily lives; they may find themselves in a situation where they do not know what the Bible says they should do; they may want to share a difficulty so that you can pray for them, especially if you are the only Christian support they have.

For these reasons it is important that the children know you are available to talk. It is also important that they know when and where to go when they want to talk to you. Finally, it is essential that unsaved children do not confuse coming to the Lord Jesus with coming to you.

In all cases you should not make yourself available at the same time as giving the Gospel invitation, so that the children never get the impression that they cannot come to Christ without coming through you, or that they are saved simply by waiting to speak to you.

An example for use with the unsaved child

"Do you really want to live for the Lord Jesus, but don't know how to come to Him? I will be glad to explain it from the Bible; come and see me. I'll be sitting here at the front when the meeting is over. Remember, I can't take away your sin - only the Lord Jesus can do that - but I will be glad to help you understand better how you can come to Him. Just come and sit with me and we can talk about it."

An example for use with the saved child

"If you have trusted the Lord Jesus as your Saviour and you have never told me about it, please let me know. I'll be standing beside the piano after the meeting is finished. I would like to know if you too have trusted the Lord Jesus as your Lord and Saviour, so that I can pray for you and perhaps help you."

Memory verses

We have not suggested a different memory verse for each lesson, so that you can spend longer teaching and reviewing those that are suggested. It is important that children learn these Bible verses in such a way that they will remember them forever.

Practise placing the flannelgraph figures

Practise using the visuals and changing the scenes before you go to teach. Become thoroughly familiar with all the figures and know when you need to use them in the lesson. Scenic backgrounds can be purchased to use with these lessons. We give suggestions before each scene, but they are by no means essential. All your teaching can be done on one plain flannel background.

Extra visual aids

On a piece of card print out the words of the central truth for each lesson; back it with pieces of flocked paper. (Use lower case letters, so that even the younger ones can read the words easily.) Put this card on the board at the beginning of the class or when you first teach the central truth in the lesson.

Additional helps

Along the left and right margins additional helps are provided, giving background information and optional ideas on how to add interest to your lesson.

These ideas are designed to incorporate different learning styles. For effective learning, some children need to see or write, others need to hear or speak, others need to touch or handle, and still others need active participation.

You can use these ideas in your club as time allows.

Review questions

For each lesson some review questions are given. These can be used after the lesson or the following week, before teaching the new lesson.

Review time, if conducted in an orderly way, can be an ideal opportunity to reinforce what you have taught, while still being fun for the children. You can use this time ...

- 1 to find out how much the children are understanding and remembering.
- 2 to help you as a teacher to know what you need to emphasise more so that the children will remember better.
- 3 to provide a time of fun in the class. The children like competition and look forward to this part of the programme. But it is more than just a game: it is a time of learning.

In this textbook only questions on the lesson are included. It would be profitable to include questions also on the songs, verse and whatever else you teach. In this way the children realise that every part of the programme is important.

Overview

<i>Lesson</i>	<i>Central truth</i>	<i>Application</i>	<i>Memory verse</i>
The annunciation Luke 1:26-47 Luke 2:1-3 Matthew 1:18-24	Jesus Christ is God the Son	Unsaved: Trust Him for He alone can save you from sin Saved: You must obey Him	“He will be great, and will be called the Son of the Highest” Luke 1:32
The shepherds hear of the Saviour Luke 2:3-20	The Lord Jesus came into the world to be the only Saviour from sin	Unsaved: If you want to be saved you must trust Him Saved: If you have trusted Him you can be sure you are saved	“Call His name Jesus, for He will save His people from their sins” Matthew 1:21
The wise men worship the King Matthew 2:1-14	Jesus Christ was born King	Unsaved: Trust Him to bring you out of Satan’s kingdom into His own Saved: Worship Him	Review Luke 1:32 and Matthew 1:21
The Lord Jesus Christ as a child Matthew 2:19-23 Luke 2:40-52	The Lord Jesus was a child	Unsaved: Compare your life with His and you will see how sinful you are Saved: You should follow His example	“For in that He Himself has suffered, being tempted, He is able to aid those who are tempted” Hebrews 2:18
The Lord Jesus Christ in temptation Matthew 3:1-4 Matthew 4:1-11 Mark 1:4-12 Luke 3:1-16,21-22 Luke 4:1-13	Jesus Christ was tempted in every way just as we are - yet was without sin	Saved: Trust Him to help overcome temptation	Review Hebrews 2:18
The Lord Jesus calling disciples John 1:29,35-50 Mark 1:16-20 Mark 2:13-17 Luke 6:12-16	Jesus Christ is calling men and women, boys and girls to be His disciples	Unsaved: Obey His call when He speaks to your heart Saved: Continue to be a faithful disciple	“If anyone desires to come after Me, let him deny himself, and take up his cross daily, and follow Me” Luke 9:23

Lesson 1

The annunciation

Scripture for teachers

Luke 1:26-47

Matthew 1:18-24

Central truth

Jesus Christ is God the Son

Application

Unsaved: Trust Him for He alone can save you from sin

Saved: You must obey Him

Memory verse

“He will be great, and will be called the Son of the Highest” Luke 1:32

Visual aids

◆ Flashcards: 1-1, 1-2, 1-3, 1-4 and 1-5

Or

◆ Figures: 1, 2, 4, 6, 7, 8 and 10

◆ Backgrounds (optional): Indoor scene and outdoor scene

Helps for preschoolers

You would need to shorten some of the teaching and application but have the children repeat with you key phrases, like “Jesus is the Son of God,” so that the main teaching of the lesson will come through even to the youngest. At various points in the story, the children could participate (see ideas in the margin of the text).

Songs

A very appropriate song for this lesson would be the “Trinity Song”. The first verse says, “I believe in God the Father, who made us every one ...” The second verse is about the Lord Jesus and the third verse is about the Holy Spirit. One verse could be learnt for the first week, and the other verses in the following weeks.

Carry-over activity

◆ Paper and pencils

And/or

◆ Make photocopies of card on page 64 for each child, or for preschoolers photocopy picture on page 65 for each child

◆ Pencils and colouring pencils

Lesson outline

Introduction

“Oh, who can that be?”

Progression of events

1 The angel visits Mary

2 The angel tells Mary she will have a child

CT

3 The angel tells Mary that Elizabeth will have a child

4 Mary responds submissively

CT

5 Mary visits Elizabeth

6 Elizabeth greets Mary

CTS

7 Mary praises God

CTU

8 Later Mary returns home

9 Joseph is sad because of the news

Climax

Joseph dreams and hears the angel’s message

CT

Conclusion

Mary and Joseph await the birth

CTS, CTU

Lesson

“Oh, who can that be?” thought Mark impatiently, as he heard knocking at the front door. He was reading a very exciting book and did not want to stop! But the knocking continued.

At last he gave in and went to the door. Through the glass he could see someone who was about his own height. When he opened the door he couldn’t believe his eyes!

“Alex! What are you doing here?” he spluttered.

Two years ago Alex had moved house to live hundreds of miles away.

“We’re on holiday, just thought I’d give you a call!” Alex grinned.

Mark was so surprised that he almost forgot to invite his visitor in!

Mary, who lived in Bible times, had a very unexpected visitor too.

Scene 1

Optional background: Indoor scene. Place Mary (1).

She was alone, probably thinking happy thoughts for she was soon to be married. She dearly loved Joseph, and eagerly looked forward to the time when they would be in their own home. She may have been planning how to make that home lovely for Joseph. They would not have much money, but Mary did not care about that. She had so many other things to make her happy. God had been so good to her. Suddenly her thoughts were interrupted!

Place angel (2).

“Greetings to you, favoured lady. The Lord is with you!”

Mary was startled. An angel! Her face showed the fear that was in her heart.

“Do not be afraid, Mary. God loves you dearly,” the angel, Gabriel, said. “You are going to become the mother of a Son. You will name Him Jesus. He will be great and will be the Son of the Most High God.”

The baby would be the Son of the Most High God!

The Bible, God’s Word, tells us many things about Him.

Place triangle (4).

Look at this triangle. It has three sides and yet is one triangle. God is one God, but He is three persons - God the Father, God the Son and God the Holy Spirit. It is God the Son we are especially thinking of today. He is God, so His life had no beginning. He had lived in Heaven with God the Father for ever and ever. He was there when the world was made. The Bible says, “All things were made through Him” (John 1:3). This was the One Who, the angel said, was leaving Heaven and becoming a baby, and Mary was going to be His mother.

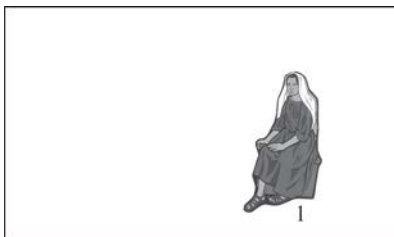

Flashcard 1-1

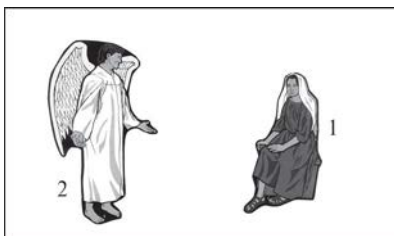

Children might enjoy role-playing the dialogue between the angel Gabriel and Mary.

Flashcard 1-2

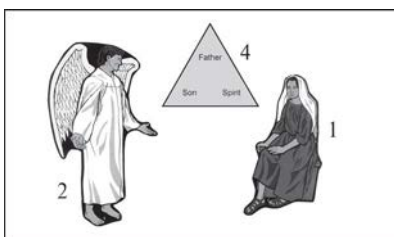

CT

Mary's thoughts must have been trying to keep up with what the angel was saying. Was this to be God's Promised One? For hundreds of years every Jewish woman had hoped for the honour of being the mother of this Promised One. Could it be happening to **her**?

"The Lord God will give Him the throne of His ancestor David. He will be King over the people of Jacob (Israel) forever. His reign will never end," Gabriel explained (see Luke 1:32-33).

And Mary knew ... yes, this was God's Promised One! She was to be His mother. But, her thoughts were all mixed up.

"I don't understand," she said. "How can this be?"

"The Holy Spirit will come upon you," the angel said. "The power of the Most High God will rest over you. So, the baby which will be born to you will be holy ... the Son of God" (see Luke 1:35).

The birth of this baby would be different from that of any other baby ever born. Every baby has a human mother and a human father. But when the only Son of the Most High God became a baby, yes He would have a human mother, but He would not have a human father.

This baby was the Son of God Himself. Little wonder Mary was amazed. She would have to talk to someone about these things. But who would believe her strange story? God had given the angel Gabriel a message about that too.

"Your cousin, Elizabeth, is also going to have a baby," he said. "Remember, Mary, God will keep every promise. Nothing is impossible with Him" (see Luke 1:36-37).

Elizabeth to have a baby! Both Elizabeth and her husband, Zacharias, were very old. A baby born to such an old couple would surely be a miracle baby!

"I am the Lord's servant," Mary replied to the angel. "I am willing to do whatever God wants. Let it happen to me as you have said." Mary believed God's promise.

The angel, Gabriel, went back to Heaven.

Remove angel (2).

We do not see and hear angels bringing God's Word to us today. We have God's message in the Bible. We know Who Jesus Christ is because the Bible tells us again and again that He is God the Son. He did not stop being God when He became a little baby.

God's Word also tells us why the only Son of God came into the world. "Christ Jesus came into the world to save sinners" (1 Timothy 1:15). Only God can save from sin - that's why Jesus Christ was coming into the world.

For preschoolers, as the angel speaks to Mary, all the little girls could put on a puzzled frown at the start. Later, all could

Flashcard 1-1

move off to tell Elizabeth the news.

For preschoolers, you could say that Mary didn't understand how God would keep His promise, but she knew He would do it in a special way.

CT

Bible scholars are unsure whether Elizabeth was Mary's cousin or aunt. Jesus and John were cousins.

To be childless was generally considered a sign of divine disfavour and brought sorrow, shame and social reproach.

CT

Let children name sins that boys and girls their age commit.

Elizabeth lived in Judea (also called Juda or Judah). Locate Nazareth (Mary's home) and Judea on a map.

Have preschoolers pretend to walk to Elizabeth's house.

Flashcard 1-3

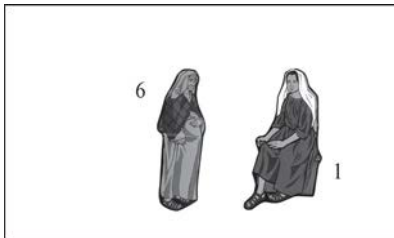

CTS

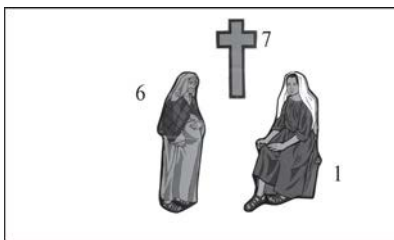

CTU

Mary didn't know all of this but she was thinking about the angel's message as she got ready to visit her cousin Elizabeth. She was anxious to know what Joseph would say when she told him about the angel and the message he had brought.

Remove all figures.

Scene 2

Optional background: Outdoor scene.

The trip to the home of Zacharias and Elizabeth took several days. And, wonder of wonders! Elizabeth knew that Mary was going to be the mother of God's Son, the Promised Saviour, even before Mary told her.

Place Mary (1) and Elizabeth (6).

"It is a great honour that the mother of my Lord should come and visit me!" she exclaimed.

Elizabeth knew that Mary's child was her Lord. Elizabeth believed in the One Whom God had promised to send. She knew that the Promised One would soon be born. He was her Lord! Christian boy and girl, never forget Who your Saviour is. He is God Almighty, pure and sinless, He knows everything. When He became a man He didn't stop being like that. If He is your Saviour, He is your Lord. That means He is in charge of your life. If your friends are going somewhere which would not please Him, what do you do? If there are a lot of dishes to be washed up after dinner, what do you do?

Allow the children to answer.

If Jesus Christ, God the Son is your Saviour and Lord, you will want to please Him.

Elizabeth was so happy about what was happening and Mary was filled with joy.

"My soul praises the Lord, and my Spirit rejoices in God my Saviour," she said (see Luke 1:46-47). Mary knew that only God could save her. She did not understand all that her child, God's Son, would have to do to save her. One day He would take the sin of the world on Himself and be punished for it.

Place cross (7).

Only God could do that! Then He would show again that He was God by rising from the dead.

Mary called God "my Saviour" (Luke 1:47). Is Jesus Christ **your** Saviour? You cannot do anything to take away your sin. He, and He alone, can save. If you turn from everything you know to be wrong in your life and trust Jesus Christ to take away your sin, because He is God's Son He can do that for you. Perhaps you want to be saved from sin, but you don't really understand how to be. I will be (*designate*

a specific place) when Club is over. When the others are going out, you can come to me and ask your questions. I will show you the answers from God's Word.

It is very important that Jesus Christ should be your Saviour. Mary could call God "my Saviour". She rejoiced because God was so good to her. Elizabeth too must have told Mary the exciting things which happened to her and her husband, Zacharias.

"Zacharias saw an angel too. The angel said that our son, whom we would name John, will make the people ready for the Lord" (see Luke 1:13).

Mary and Elizabeth and Zacharias had many happy days together. They must have thought and talked a lot about the babies that would be born. In some ways they would be very different from each other. Can you think of ways in which they would be different?

Allow the children to answer.

Elizabeth's baby had a human father, Zacharias; Mary's baby would have no human father, He was the Son of God. Elizabeth's baby would begin his life nine months before he was born; but the Son of God had already lived for ever and ever in Heaven.

Just before Elizabeth and Zacharias' son was born, Mary went home. As she went she must have wondered, "What will Joseph say? Will he understand?"

Scene 3

Optional background: Indoor scene or plain background. Place Joseph (8).

Joseph was sad and very puzzled about Mary going to have a child. He was thinking it would be better if he did not marry her.

As Joseph tried to sleep, he started to dream. Suddenly, an angel stood by him!

Place angel (2).

"Joseph," the angel said, "do not be afraid to take Mary as your wife. It is true that she is going to have a baby, but this baby will be the Son of God. You will name Him Jesus, for He shall save His people from their sins" (see Matthew 1:20-21).

God left Joseph in no doubt about who this baby was - He was the only Son of God. It is wonderful to think that He willingly left Heaven and became a baby, and yet He never stopped being God. We cannot understand this but the Bible teaches it, so we know it is true.

Now Joseph understood. It was hard for him to believe anything so wonderful - he and Mary would be part of a miracle! God was coming to Earth as a baby. A greater miracle had never happened. Joseph was so happy; not only that Mary would be his wife, but because God was keeping His promise and doing this wonderful miracle

Ask the children what kinds of things Mary and Elizabeth might have done to get ready for their babies. Be sure to mention prayer!

Preschoolers could pretend to sleep or role-play Joseph dreaming of the angel.

Flashcard 1-4

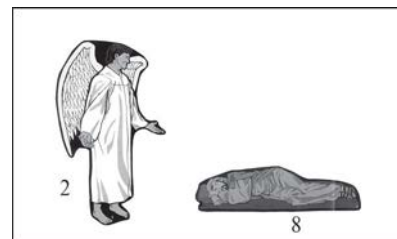

CT

For preschoolers, as the angel speaks to Joseph, all the little boys could look sad at the beginning. Later all could repeat the words of the angel, "The baby will be the Son of God." Later all could repeat, "I am to call Him Jesus. He will be the Saviour."

You might want to have an older child look up Isaiah 7:14 and read God's promise of a Saviour. Explain that the name Immanuel means "God with us".

Flashcard 1-5

CTS

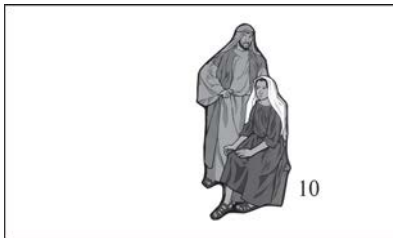

CTU

Review game

Pull a string

Cut 12 strings of different lengths. Poke a hole through each cup of an egg carton and push one end of a string through each hole. Close the lid and turn the carton over.

Divide into two teams and ask questions alternately of each.

When a child answers correctly, he may pull a string out of the bottom of the egg carton.

As teams earn more strings, they may tie them together or lay them end to end.

The group with the longest string wins.

through her. What an honour it was for Mary to be chosen to be the mother of the Son of God.

Remove all figures.

Scene 4

Optional background: Simple indoor scene or plain background. Place Mary and Joseph (10).

Joseph obeyed God's message and married Mary. They were joyful as they lived together in their little home in Nazareth. Joseph worked in his carpenter's shop and Mary kept the house. They waited for the time when God's Son would be born.

But has His coming made any difference to you? If you have trusted Him as your Saviour the answer to that question is "yes". Because He came, you have been saved from sin. Remember He is your Lord, He is in charge of your life. He is the One you must please. He is the One you must obey.

It may be that in your heart you know that His coming to Earth has made no difference to you, but you are concerned that you've been disobedient to God. You want to be saved from sin. I can't do that for you. Only God can save. Will you trust Jesus Christ, God's only Son, to save you? As we close, tell Him quietly in your heart that you are sorry for your sin. Ask Him to save you. He can and will save you when you trust Him. God promises, "Whoever calls on the name of the Lord shall be saved" (Romans 10:13).

Review questions

The odd numbers are easy questions and the even numbers are harder, so you can use it with a wide age range.

- 1 Give the names of the two people who were hoping to be married. (Mary and Joseph.)
- 2 Name the two people who had been married for a long time, but had no children. (Elizabeth and Zacharias.)
- 3 How did Mary come to know that she would have a baby? (The angel Gabriel visited her and told her.)
- 4 The angel told Mary that the baby would be the "Son of the Most High God." What did that mean? (He would be God's Son.)
- 5 The angel also told Mary some other news - what was it? (Mary's cousin, Elizabeth, was also going to have a baby.)
- 6 Name two big differences between the two babies that were going to be born. (Elizabeth's baby had a human father, Zacharias; Mary's baby would have no human father, He was the Son of God. Elizabeth's baby would begin his life when he was born; but the Son of God had already lived for ever and ever in Heaven.)

- 7 How did God tell Joseph who baby Jesus really was? (An angel visited him in a dream.)
- 8 God had made a promise many times to His people. Now this promise was being kept. What was it? (God promised to send a Saviour to the world.)
- 9 Why did Jesus come into the world? (To take away our sin.)
- 10 If Jesus is God's own Son, how should we react to Him? (Ask Him to save us from sin, and then obey Him.)

Preschool review questions

- 1 What did God promise to send to the world? (A Saviour.)
- 2 How did God send the Saviour? (As a baby.)
- 3 Who told Mary and Joseph that the Saviour would come? (An angel.)
- 4 What did the angel say they should name the baby? (Jesus.)

Carry-over activity

Jesus Christ is God the Son

Photocopy the card on page 64 for each child. Explain to the children as follows.

God sent His Son to show His love for you. How will you show Him your love for Him today? During the coming week, on the back of the card write ways in which you have obeyed God.

Carry-over activity for preschoolers

Jesus Christ is God the Son

Photocopy the picture on page 65 for each child to colour, either during club or at home.

It might be a help to write down some questions that will help you to guide conversation while the children colour. Help them to talk about Who Jesus is.

Relating the activity to the story they heard and to the application is an important part of making the handwork time meaningful.

Alternative review game

Spaghetti

Place pieces of string of different lengths inside a saucepan and cover with lid. One end of each piece of string should be left outside the saucepan.

Play as "Pull a string" (above) and see which team gets the longest piece of "spaghetti".

Preschool review game

Gift box

Place four construction paper squares on the floor in a path leading to a large wrapped box with a removable lid. Inside the box have small prizes, stickers or wrapped candies.

When a child answers a question, he stands on the first square.

When the next child answers a question, he stands on the first square while the first child moves to the second square.

When the fourth question is answered, the first child reaches the gift box and each child earns a prize.

Repeat as interest and time allow.

Lesson 2

The shepherds hear of the Saviour

Scripture for teachers

Luke 2:1-20

Central truth

The Lord Jesus came into the world to be the only Saviour from sin

Application

Unsaved: If you want to be saved you must trust Him

Saved: If you have trusted Him you can be sure you are saved

Memory verse

“Call His name Jesus, for He will save His people from their sins” Matthew 1:21

Visual aids

- ◆ Flashcards: 2-1, 2-2, 2-3, 2-4, 2-5 and 2-6

Or

- ◆ Figures: 10, 11, 12, 13, 14, 15, 16, 17, 18, 19 and 20
- ◆ Backgrounds (optional): Modest interior scene, outdoor scene, stable scene and outdoor night scene

And

- ◆ Visualise the central truth with a cross (see page 66)

Songs

- ◆ “Away in a Manger” (or another suitable Christmas carol)
- ◆ “The Trinity Song”
- ◆ “Good News, Good News”

Carry-over activity

- ◆ Paper and pencils
- ◆ Tract for each child

Lesson outline

Introduction

Mary and Joseph prepare for journey to Bethlehem

Progression of events

- 1 They travel to Bethlehem
- 2 They arrive
- 3 They stay in a stable
- 4 Jesus Christ is born *CTU*
- 5 The shepherds arrive and worship Him

Climax

- They tell their story
- The angel appeared *CT*
 - He told of a Saviour *CTS*
 - The sky filled with angels

Conclusion

The shepherds leave and tell others *CTU*

Teaching the memory verse

Introduction

How many of you like to receive gifts?

Let children share.

Today's memory verse tells about a very special gift God gave to the whole world - Jesus Christ.

Presentation

Show your Bible, explaining that it is the Word of God. Read the verse from your Bible and describe how you found it. Have the children read the verse with you from the visual.

Explanation

Call His name Jesus - God sent His Son to Earth as a baby. Mary was the one chosen by God to be His earthly mother. God told Mary and Joseph to name His Son Jesus, which means "the Lord saves".

for He will save His people from their sins - Every person born into the world has sinned and God says sin must be punished. But Jesus was not just a man. Jesus is God and He never sinned. God sent Jesus to die on the cross to take the punishment for sin, so you could be saved by trusting Jesus as your Saviour.

Application

Unsaved: Have you been saved from the punishment for your sin by trusting Jesus as your Saviour? You can do that today! Listen carefully as we talk more about that during our lesson.

Saved: If you have already trusted Jesus as your Saviour, God has saved you from your sin by His perfect plan. God wants to continue to work out His perfect plan and give you His very best. You need to let Him guide you every day.

Repetition

"Clap a word"

Repeat the verse a number of times, then have a child stand behind the visualised verse with his back to the class. Choose another child to point to a word on the visual. Lead the children in reciting the verse, but when you get to the chosen word, clap instead of saying it. The child behind the visual then tries to guess the word. Choose two different children and repeat as time allows.

Lesson

Scene 1

Optional background: Modest interior scene or plain background. Place Mary and Joseph (10).

Mary and Joseph were getting ready for a journey. The Roman Emperor, Caesar Augustus, had made a law that all the people in his kingdom should pay tax to the Roman Government. Everyone had to go to his own city and stay there until the tax officials came to tell each man how much he had to pay. Mary and Joseph would have to go to Bethlehem. They lived in Nazareth, but Joseph was from the family of David, and Bethlehem was the City of David. Mary and Joseph got together all that they would need for the journey.

Remove all figures.

At last they were ready to leave. "I've brought the most comfortable saddle," Joseph may have said as he placed it on the donkey's back. "Are you sure you will be all right, Mary?"

Scene 2

Optional background: Outdoor scene. Place Mary and Joseph (11).

"Yes, Joseph, I'll be just fine."

Mary would have known the road to Bethlehem was not easy with so many hills and valleys and rocky places. It would be especially uncomfortable for Mary, because of the baby she was expecting. It would take four or five days of hard travel to reach Bethlehem, the City of David, as it was sometimes called. Each night the travellers looked for a place to sleep. Perhaps along the way there were people who gave them a room for the night. Some nights they may have slept under the stars. Each day brought them nearer Bethlehem.

When they finally arrived, Mary and Joseph just wanted to rest. They were so weary. Would their relatives have room for them? No! Other guests had arrived first and no-one had a room. Bethlehem was filled with people who had come to register for the taxing.

"We will find room in the inn," Joseph may have suggested. But that too was impossible. Even the inn was filled! What could they do? When Joseph looked at Mary, he must have seen that she was not feeling well. Mary knew her baby would soon be born.

"Joseph, we must find somewhere."

Maybe someone sent them there. Maybe they found it themselves. But there it was.

Remove all figures.

The stable! Mary and Joseph settled into the stable.

Pretend that you're going on a trip. Talk about where you'll go, then pretend to pack and travel.

Have a child read 2 Samuel 5:7-9 to discover why Jerusalem was called the "City of David". During the class, ask the child to explain.

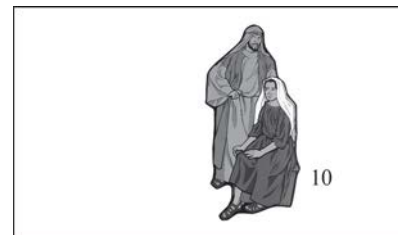

You may want to ask a child (prepared beforehand) to read Micah 5:2.

Before club give one of the older children a map

Flashcard 2-1

of Palestine at the time of the birth of Christ. Ask him to find Nazareth and Bethlehem. Show him how to measure the distance. Have the child show the others where the two towns were. Point out the distance between the towns, comparing it to the distance from your classroom to a place 160 km (100 miles) away.



Children might enjoy role-playing this part of the story.

Preschoolers could pretend to knock on doors in Bethlehem. Each time the teacher replies, "Sorry, no room."

Some modern scholars believe Jesus was born in a stable that was part of a house. Many peasant homes of that time included about a 1.2 metre (4 ft) drop where the animals were kept at night. The manger was built into the floor.

Flashcard 2-2

Preschoolers could pretend to find clean straw, put it in a manger and hold the baby.

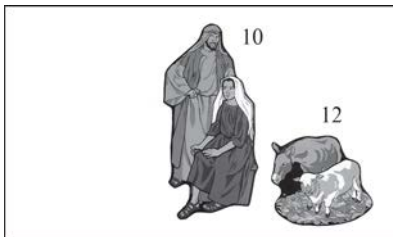

CT

Flashcard 2-3

Preschoolers could role-play by wrapping a doll in a blanket.

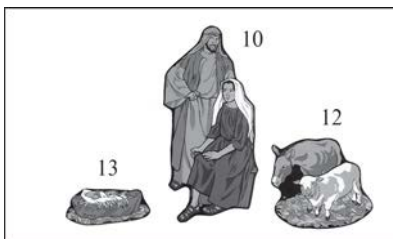

As a change of pace, have the children stand and quietly sing "Away in a manger." Music can help some children remember truths taught.

CTU

Scene 3

Optional background: Stable scene.

Most stables are not very clean and, because of the animals that live in them, they are also rather smelly. Joseph probably looked for some clean straw.

Place Mary and Joseph (10) and animals(12).

Perhaps it was Mary who first noticed the manger. It was really a feed trough for the donkeys or cattle. But Mary knew that manger would be used for something else that night.

"Joseph," she may have said, "please bring some of that clean straw and put it in the manger."

That night it happened - God's precious Son came into the world as a tiny newborn baby! He was a real baby and looked like any other boy. He cried. He had to be fed and cared for. He was a little baby boy and at the same time He was God! We cannot understand how such a thing could happen, but it did! But there was something different about this baby. You know how very little children show bad temper, and no-one ever shows them how to. They disobey their mother. They just know how to do this. All babies are born wanting to go their own way and not God's, they are born sinners. This baby was different, He was pure and sinless.

Place manger with baby Jesus (13).

Mary and Joseph wrapped Him in soft cloths and laid Him in the manger. They were happier than they had ever been before. That which they wanted more than anything else happened. They likely remembered again God's promises of long ago. "The virgin shall ... bear a Son, and shall call His name Immanuel [God with us]" (Isaiah 7:14). And another, "Unto us a Child is born, unto us a Son is given ... and His name will be called Wonderful, Counsellor, Mighty God ..." (Isaiah 9:6). They tried to understand the miracle of that new baby being God.

Their faces must have showed the joy they felt as they praised God. They just wanted to thank Him for keeping His promise. Their praises must have been mixed with asking too. Surely they asked God to help them care for this baby, the Son of God.

Mary and Joseph had no problem thinking of a name for the baby. The angel had said, "Call His name Jesus, for He will save His people from their sins" (Matthew 1:21).

"Jesus" means Saviour, but what does "Saviour" mean? Supposing you were swimming in the sea, got caught in a strong current and were in real danger. If someone on shore spotted you, swam in and rescued you, we would say that they had saved you. A Saviour is someone who saves, or rescues.

Remember we said that you are born wanting to go your own way rather than God's, so you are disobedient and sometimes bad tempered. You find it easy to disobey God's commands. You cannot change yourself, you cannot free yourself from sin. The Bible says that "sin, when it is full-grown, brings forth death" (James 1:15) - that means to be put away from God for ever and ever. You need Someone to save you from your sin.

The Lord Jesus came to be the only Saviour from sin. He became a man so that He could die for the sins of men - people like you and me. He had no sin, but He was punished as if the sin of the world was His own. Only God could take away the sin of the world. The Lord Jesus is God and man and that's why He is the only Saviour from sin. He is alive today and can break sin's grip on your life. He can take away all your sin, He can save you from being separated from God. His very name means "Saviour", that's why Mary and Joseph called Him Jesus.

The excitement made Mary and Joseph forget how tired they had been. They were not sleepy now, though everything was quiet and still. It seemed as if Bethlehem had gone to sleep. Mary and Joseph were alone with the miracle baby.

All at once they heard voices!

"Joseph, I think someone is coming." Mary may have been a bit troubled when she heard the voices.

Who could it be? They looked toward the door just as some shepherds stepped inside.

Place shepherds (14).

They were talking excitedly among themselves.

"This is the place," they said. "Here is the baby. It is just as the angel said!"

Mary and Joseph were curious. The angels? They watched as the shepherds moved toward the manger. They walked softly and then knelt beside the baby. Reverently the shepherds looked at Him, their faces filled with wonder. This was God's Promised One! - the One for whom the people of Israel had waited for years and years. Happy tears must have spilled over as they worshipped God the Son, the baby in the manger. Don't you think the shepherds thanked God for keeping His promise and for letting them be a part of this great miracle?

Quietly Mary and Joseph waited. But finally they must have questioned, "What about the angel?"

Slowly the shepherds turned from the manger to tell their story. It would have been unbelievable if Mary and Joseph had not already seen unbelievable things happen.

Remove all figures.

Flashcard 2-5

Whisper these words with breathless excitement.

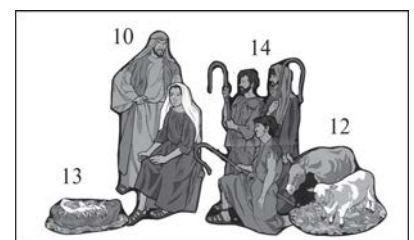

Flashcard 2-4

Let your voice and facial expression show the excitement of this event.

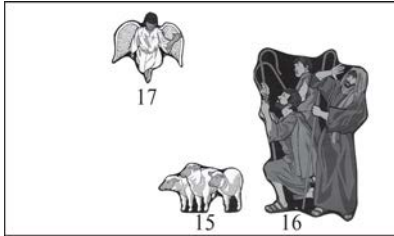

The promise God gave in Genesis 3:15 was fulfilled in Christ's death and

CT resurrection. The angel's announcement used very significant words - "Saviour" (deliverer), "Christ" (anointed one; Messiah), "Lord" (ruler over all). This was the One all Israel had waited for.

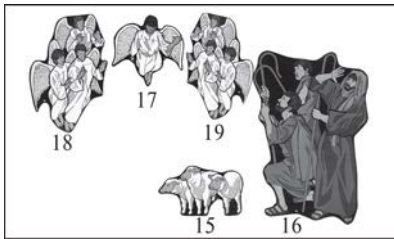

Let children repeat the angels' words with you.

CTS

Scene 4

Optional background: Outdoor night scene. Place sheep (15), shepherds (16) and angel (17).

"We were in the fields. Some of us were watching the sheep. Others were taking their turn to sleep. Suddenly we were all wide awake! The sky was as bright as day. Then we saw the angel and he spoke."

Hearing the shepherds' story, Mary and Joseph remembered the angel who came to them. Was it the same angel? They were eager to know what he told the shepherds.

"First, he told us not to be afraid. We knew he was from God and we were really frightened. The angel tried to quiet our hearts. He said he was bringing good news of great joy which would be for all people." The shepherds remembered the exact words of the angel, "For there is born to you this day in the city of David a Saviour, who is Christ the Lord" (Luke 2:11).

The angel said that the Lord Jesus was the Saviour. Why could someone else not die for the sin of the world?

Allow the children to answer.

Every other person was a sinner deserving God's punishment. The Lord Jesus was sinless, so He could die for the sins of other people. Why did the Lord Jesus become a man in order to be the only Saviour? It was men, people, who had sinned and so a man was needed to take their punishment. Yet only God could do such a great work as taking away the sin of many, many people. So the Lord Jesus is the only Saviour from sin.

Words of memory verse could also be placed on the board at this point.

The angel said that they would find the Saviour as a baby, wrapped up and lying in a manger.

The men must have explained, "While we were trying to understand all this, something else happened. The sky was suddenly filled with angels!"

Place angels (18 and 19).

"They were praising God and saying, 'Glory to God in the highest, and on earth peace, goodwill toward men'" (see Luke 2:13-14).

Little wonder the angel choir sang about the birth of such a great Saviour! If you have already truly trusted Him to save you, you can be absolutely sure He has saved you. Everything we have learned about Him tells us that He can and does save. If He is your Saviour, the Bible says you are saved from being punished for your sin (Romans 8:1). He has broken sin's grip on your life. That's why you see changes in your own life. One day He will bring you to God the Father in Heaven. You will be pure and perfect for ever and ever. He is a great Saviour. He cannot fail you. He is the only Saviour, and so the angels sang at His birth.

“They were gone as suddenly as they had come,” the men said. “We realised that there was no reason to fear. It was because God loves us that He sent us the message from Heaven. So, we decided to come to Bethlehem to look for Him ... and we have found Him. We have seen Him, the Christ - God’s Promised One!”

Scene 5

Optional background: Stable scene. Place Mary and Joseph (10), manger with baby Jesus (13), shepherds (14) and animals (12).

Mary and Joseph may have told the shepherds the wonderful things that took place in their lives before this night.

Perhaps Joseph told them, as they gathered close to the manger again, “His name is Jesus [Saviour], for He will save His people from their sins.”

The shepherds must have been amazed. Their words of thankfulness as they worshipped Him could not express all the joy of their hearts.

Remove all figures.

Scene 6

Optional background: Outdoor scene. Place shepherds (14) and crowd (20).

When the city of Bethlehem awoke the next morning, they heard news of strange happenings. To all who would listen, the shepherds told their story. They told of angels ... the good news from Heaven ... and the baby. God’s Promised One, Christ the Lord, was born!

The shepherds praised God as they went back to their sheep.

The shepherds heard that the Saviour had been born and they came to Him. What about you? Today you’ve heard that He is the only One who can save you. He can take away the sin that cuts you off from God. He can break the hold that wrong has on your life. You cannot see Him for He is in Heaven now, but you can trust Him with all of your heart. If you really want Him to save you, trust Him to do that for you now. He will, for the angel said, “Call His name Jesus, for He will save His people from their sins” (Matthew 1:21).

Most people could not believe it.

“What a strange story,” they said, as they shook their heads and went their way.

Mary thought and thought about all that had happened and wondered about the future. God’s promise for the future could be counted on, just like His promises of the past. She could thank Him for that. The good news from the angel was for all people. How do you feel about what took place that night? Don’t be like those people who heard the good news, but they did not come to the Saviour. Don’t go on in your sin, cut off from God. Jesus Christ was born to be the Saviour. He is still the only Saviour. If, with all your heart you want to be

Flashcard 2-5

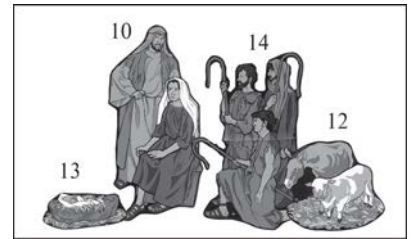

Flashcard 2-6

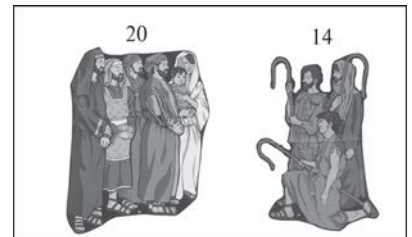

CTU

CTU

saved from sin, trust the Lord Jesus now. You could tell Him something like this, “Lord Jesus, I have done so much that is wrong, I know I need to be saved. Thank You for dying for me; please take away my sin and be my Saviour.” He will hear you. He will save you. Remember our Bible verse - “Call His name Jesus, for He will save His people from their sins” (Matthew 1:21).

Review game

Mystery points

Prepare 10 slips of paper with point values on each. Cut a slit through each cup of an egg carton, then partially insert each slip so that the point values are concealed inside the carton. Close the lid and turn the carton over.

Divide the class into teams and ask questions alternately of each.

When a child answers correctly, he pulls a slip of paper from the bottom of the carton and earns these points for his team.

The team earning the most points wins.

Preschool review game

Pull a string

Follow the instructions in lesson 1 but don't divide into teams.

Use preschool questions from lessons 1-2.

Help the preschoolers lay the strings end to end to form one string and see how long it gets.

Review questions

- 1 Who was the person who said that Joseph and Mary had to travel to Bethlehem? (There are two answers - God and the Roman Emperor. Accept the answer(s) that you taught.)
- 2 Why was it a specifically difficult journey for Mary? (Because of the baby she was expecting.)
- 3 Why did Joseph and Mary give the name “Jesus” to the baby? (The angel had told Joseph that the baby was to be called “Jesus”.)
- 4 Why was He called “the Saviour”? (Jesus had come into the world to save sinners from sin.)
- 5 Where did Joseph and Mary finally sleep? (In a stable.)
- 6 Why was Jerusalem so full? (Many other people had also come to Jerusalem to register.)
- 7 Who were the first visitors to see the baby? (Some shepherds.)
- 8 How did they know where to find Him? (The angels told them that the baby would be wrapped up and lying in a manger.)
- 9 The angel told them that the Saviour had been born. Why is that “Good News”? (God’s Son, the Saviour, had been born; He had come to take away our sins.)
- 10 What two things did the shepherds do after seeing Jesus? (They worshipped Him and then told the story to everyone who would listen.)

Preschool review questions

- 1 When Mary and Joseph went to Bethlehem, where did they spend the night? (In a stable.)
- 2 What exciting thing happened in the stable that night in Bethlehem? (Jesus was born.)
- 3 Who were the first to come see the baby Jesus? (Shepherds.)
- 4 Why do you need a Saviour? (To be forgiven of sin.)

Carry-over activity

Sharing the Good News

As a group, list ways to help others hear the good news. Your list might include praying for them, sharing a tract, showing kindness (especially to those who are unkind), bringing them to Good News

Club[®], taking them to church or a church event, sharing your testimony, etc.

If time allows, have each child write down the names of three people they know who are unsaved. Challenge the children to pray for the people on their list each day this week and share the good news with them as God leads.

If possible, provide each child with a tract. Excellent tracts are produced by CEF[®] and may be obtained from your CEF office.

Lesson 3

The wise men worship the King

Scripture for teachers

Matthew 2:1-14

Central truth

Jesus Christ was born King

Application

Unsaved: Trust Him to bring you out of Satan's kingdom into His own

Saved: Worship Him

Memory verse

Review Luke 1:32 and Matthew 1:21

Visual aids

- ◆ Flashcards: 3-1, 3-2, 3-3, 3-4, 3-5 and 3-6

Or

- ◆ Figures: 2, 8, 21, 22, 23, 24, 25, 26 and 27
- ◆ Backgrounds (optional): Outdoor night scene with starry sky, desert foreground scene (or tan flannel on a dark board), palace scene, outdoor scene, house interior scene and indoor scene.

And

- ◆ Visualise the central truth on a crown (see page 67)

Songs

- ◆ "Love, Love, L-O-V-E" (to emphasise the Gospel)
- ◆ "You are a wonderful God" (to emphasise worship)

Carry-over activity

- ◆ Photocopy of tokens on page 68

And/or

- ◆ Photocopy the cross on page 69 for each child
- ◆ Scissors and pencils

Lesson outline

Introduction

The wise men see the star

Progression of events

- 1 They understand its meaning *CT*
- 2 They prepare to travel to Judah *CT*
- 3 They make the journey
- 4 They arrive in Jerusalem
- 5 Jewish leaders say He will be born in Bethlehem *CT*
- 6 Herod meets wise men
- 7 Herod asks them to tell him where to find the King *CTU, CTS*
- 8 Wise men follow star to Bethlehem

Climax

- 9 They find the Lord Jesus
- 10 They worship Him *CTS*
- 11 God warns them not to return to Herod
- 12 They travel home another way *CTS, CTU*

Conclusion

Angel tells Joseph to go to Egypt

He obeys *CTU*

Lesson

Such excitement! The word must have passed from one group to another. "Look at that star! What is it?"

Long ago in the time of our Bible lessons, many men (who were called "wise men") lived in an eastern land. Some of these men gave advice to their king. They helped rule their country. They were men with much education. Some of them studied the stars.

Scene 1

Optional background: Outdoor night scene with starry sky.

One beautiful night some of these men saw the "new star".

Place wise men (21) and star (22).

They would have hurried to their books.

"What do the books say? Is there supposed to be a comet?"

No, there was no comet predicted. What would cause such a bright star to appear from nowhere? These men knew the stars never change. Winter after winter the same stars appear in the sky. Summer after summer the same stars are seen. The planets move here and there, and these men understood that. This was something different. What did it mean?

Somehow - we don't know how - these men understood that the star meant the birth of a king in the land of Judah. They were right, the Lord Jesus Christ, a great King had been born. In Heaven He had forever been Lord over the angels; they obeyed His commands and sang His praise. He had more power than all the kings of the Earth together! Although He had been born as a baby, He never stopped being King. God, Who made the heavens and the Earth, could surely put a special star in the sky to announce the birth of His King.

The angel told the shepherds that the good news was for all people. The star announced the good news to the wise men.

"Let us go and investigate the reason for this star," the wise men said.

It would be a long journey.

Remove wise men (21).

Camels would be needed to cross the desert sands. Food, clothing, money would be needed for many weeks. It would be a dangerous trip too. A small caravan would surely be attacked by bandits in the desert. If the caravan had many men and camels, the large group would provide safety from robbers.

"We will want to take gifts from our country to the King," they said.

The gifts were chosen carefully.

- ◆ Gold - that would be a precious gift.

Flashcard 3-1

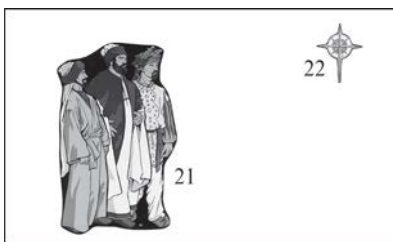

Preschoolers could pretend to be the wise men pointing to the star.

CT



Children might enjoy acting out this portion of the story. Preschoolers could pack for the trip, walk, eat snacks, slowly ride their camels, lie down to sleep, etc.

- ◆ Frankincense - an incense which was often used in worshipping God at the big temple.
- ◆ Myrrh - an expensive perfume from that eastern country.

These rich gifts from their land were suitable for a king. But, the very best gift of the wise men was the gift of themselves. They were willing to leave their homes and families, to give much of their time to take a long, hard, dangerous trip for the One they believed to be King of the Jews. How much they were willing to give up for One they knew so little about! But they knew He was a King. We know so much more about Him. God gave Him to be our Saviour. But did you know that the Bible tells us He is King? He is God, so He can do whatever He wishes. He is far, far greater and more powerful than other rulers and governments. He rules over them all. The Bible says He is King of kings (1 Timothy 6:13-16). This was the King the wise men looked for.

Scene 2

Optional background: Desert foreground scene, or tan flannel on a dark board. Place wise men (23).

The caravan started across the desert. The heat from the sun and burning sands in the daytime made travel uncomfortable. After sunset the desert was cold. The men wrapped themselves in blankets and slept close together inside their tents. They kept their treasure gifts close. Someone was always on watch duty, ready to alert the others in case of danger. Days, weeks, months went by. Still the caravan moved in the direction of the new star, even though sometimes it could not be seen.

Remove star (22).

At last they entered the land of the Jews. Where would they find the King? Surely in Jerusalem, the capital city.

Remove all figures.

The travellers must have put on their best robes, which they had been saving for the time when they would meet the King. Looking at them, the people of Jerusalem would have known immediately that these men were important visitors, and that they had come from far away.

“Where is He that is born King of the Jews?” they asked. “We have seen His star in the east and are come to worship Him.”

Scene 3

Optional background: Palace scene.

The King of the Jews! No-one hearing the question knew anything about the King of the Jews. Should Herod be asked? Herod was king. Everyone knew he had a terrible temper. If he heard about another king ...

CT

Flashcard 3-2

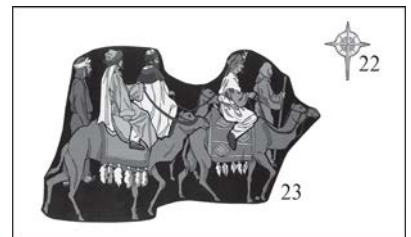

Show Jerusalem on a map.



Flashcard 3-3

Turn to Micah 5:2 in your Bible.

CT

But soon Herod did hear.

Place Herod (24) and Jewish leaders (25).

“I believe you people expect a king to come,” he said. “Where is he to be born?”

The Jewish leaders had the answer. “In Bethlehem, in the land of Judah,” they said, “for the prophet wrote, ‘But you, Bethlehem, in the land of Judah, are not the least among the rulers of Judah; for out of you shall come a Ruler who will shepherd My people Israel.’” (See Micah 5:2 and Matthew 2:6.)

Hundreds of years before the Lord Jesus Christ came to Earth, God had said that the One He would send would be a “governor”, or a ruler.

We think the ruler of our land is very important and he is. We obey and respect him, but we do not bow down before him as if he were a god. The Lord Jesus is a heavenly King, the King over every other ruler and king. He is God’s only Son. So we should worship Him, we should love Him and obey Him. But Herod would never welcome another king!

Remove Jewish leaders (25).

Scene 4

Optional background: Palace scene.

Secretly he called the wise men.

Place wise men (21).

“Just when did you first see the star?” the king asked.

Learning of the investigation, the preparations and the long trip, Herod was careful to take special note as to the time the star appeared.

“The writings of the Jews say their King is to be born in Bethlehem. Go there and search carefully until you find Him.” Perhaps Herod almost whispered the next command. “When you have found Him, come and tell me, so that I may come and worship Him too.”

Herod had got it all wrong! He thought the Lord Jesus Christ would try to take his place! This was not the kind of King the Lord Jesus was. Later He said, “My kingdom is not of this world” (John 18:36). He came to rule in the hearts and lives of men and women, boys and girls. That would be His kingdom!

The Bible tells us that there are two kingdoms in the world. One is the kingdom of Satan, the enemy of God. That’s the one you are in when you are born; because you are in it you often disobey God. Your mother asked you to stay indoors while she goes to the shop. “I’m expecting a telephone call from Aunt Anne. If she calls, you take it,” she said. Not long after she has gone your friend calls. “Come out to play, I’ll let you ride my new bike,” he coaxes. If you go God’s

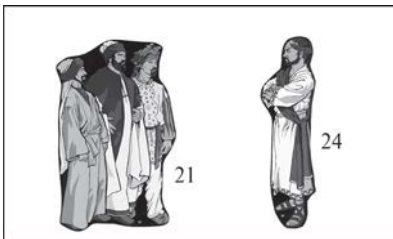

Ask the children, “How is King Jesus different from all other kings?” (He is King of kings, all-powerful, all-wise, rules in hearts, etc.)

CTU

Let children name ways boys and girls their age sin.

way, you obey your mother and stay in. But if you don't, you put yourself first, you go for that ride. You want your own way, not God's.

The other kingdom is Jesus Christ's. He rules over those whom He has rescued or saved from Satan's kingdom. Those whom He has saved are glad to obey Him as their King. So, for example, they spend Sunday the way their King wants. What would He want you to do on Sunday? Which kingdom are you in? The Lord Jesus is the only One Who can rescue you from Satan's kingdom. He is the Almighty King.

Herod didn't know what kind of King Jesus Christ would be. He just wanted to be rid of Him. Anyone who knew Herod would know he was lying. He had no intention of worshipping Him. King Herod was a wicked, mean man, who cared for nothing but having his own way. But, the wise men did not know that the king did not mean what he said.

Remove all figures.

Scene 5

Optional background: Outdoor scene.

The wise men were excited as they left the palace. Facing toward Bethlehem they became even more excited.

Place wise men (23) and star (22).

"Look," they exclaimed, "the star!"

There it was again! Now it was above Bethlehem. Their camels did not take long to cover the six miles between Jerusalem and Bethlehem. The men kept their eyes on the star every moment. As they entered Bethlehem the star moved ahead of them. Then it stopped and rested above a house. What a miracle!

Scene 6

Optional background: House interior scene. Place Mary, Joseph and Jesus (26), and wise men (27).

Almost breathlessly the wise men entered the house and they found the Lord Jesus - "the young Child with Mary His mother," the Bible says (Matthew 2:11) - the Lord Jesus Christ, the Son of God, the Messiah, the King of the Jews, the One who would save His people from their sins.

They worshipped Him. They were glad they had come to praise Him and to say thank you. No hardship had been too great for this moment, this moment when they could bow before the King of the Jews. They gave their treasures - the gold, the frankincense and the myrrh.

These were clever, wealthy, important men, but they bowed before the little child. If the Lord Jesus has taken you out of Satan's kingdom and brought you into His, you can learn a very important lesson

CTS

Flashcard 3-2

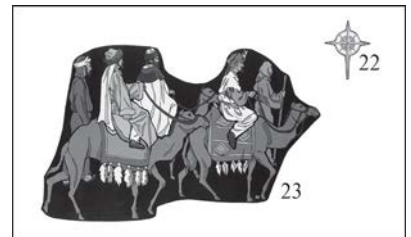

Almost two years may have passed from the time the wise men first saw the star until they arrived in Jerusalem. Joseph, Mary and Jesus would have been able to find a house to live in after everyone else returned home.

Flashcard 3-4

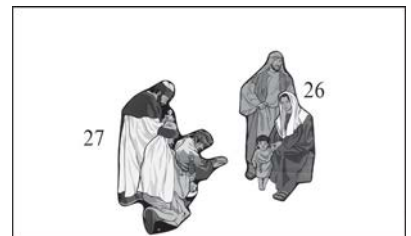

Scripture doesn't state how many wise men there

CTS

were, although it is often assumed there were three because three gifts

were given. Have the children repeat what the three gifts were. Children would enjoy smelling myrrh (or a similar perfume) and lighting incense.

from these men. Think about who your King is, Jesus Christ the Son of God. As you learn more and more about Him, keep thanking Him for being so great, so wonderful. This is called “worshipping” Him, and that’s what the wise men did. So when you speak to your King, don’t just ask for things, take time to think of His greatness and power and love; thank Him for being so great and good. When you speak to Him, always show reverence. It’s because He is King that we sometimes kneel and bow our heads when we pray. When someone is speaking out loud to Him, perhaps in church, don’t giggle or whisper. Remember He is King and worship Him as the wise men did.

Remove all figures.

Scene 7

Optional background: Outdoor scene.

Before the wise men went to sleep that night they may have reminded one another, “Tomorrow we will go back to tell King Herod we have found the King of the Jews.”

But, in the morning things were different!

“I had a dream last night,” one of the men said. “God warned me that we should not go back to King Herod.”

The men were agreeing. “We are not to return by the way of Jerusalem, but to go back to our country another way.”

Place wise men (23).

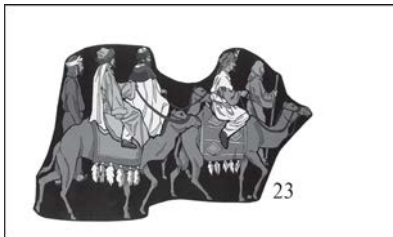

Flashcard 3-2

CTS

The wise men went home knowing that they had found the King. Have you found the King? Is Jesus Christ the King of your life? If He is, remember to worship Him. Do you remember what that means?

CTU

Perhaps today you know that you are in Satan’s kingdom, but with all your heart you long to be saved from it. The Lord Jesus is King over all. He can bring you out of that kingdom into His (Colossians 1:13). Will you not ask Him to do that for you today, ask Him to rule your life from now on?

Scene 8

Optional background: Indoor scene. Place Joseph (8) and angel (2).

God, Who knew Herod planned to kill the Lord Jesus, sent His angel to warn Joseph.

“Take the young child,” the angel said, “and Mary, His mother, and hurry to Egypt. Stay until I send you word again, for Herod will try to kill Him.”

The trip to Egypt would be a long trip and Joseph would need extra money. Do you think the gifts of the wise men would be more than enough to provide for every need? How glad the wise men would have been to know that God had used their gifts to care for His Son.

Flashcard 3-5

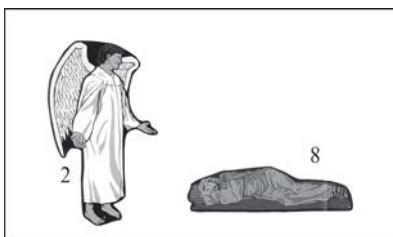

Herod was not going to get rid of this King so easily! Unlike Herod, the Lord Jesus was going to rule for ever and ever. His is a great Kingdom. There are people in it from all over the world. There are people in it who lived long ago. There are people in it who are alive today. All the enemies of Jesus Christ will be defeated and He will rule over His people for ever and ever. The Bible says, “of His kingdom there will be no end” (Luke 1:33).

Think carefully about which kingdom you are in. If you really want to be rescued from Satan’s kingdom, trust Jesus Christ, the King of kings, to save you. God’s Word says, “He is ... able to save to the uttermost [or completely] those who come to God through Him” (Hebrews 7:25). Tell the Lord Jesus, “Lord Jesus, I know You are King. I want to be in Your kingdom. Please set me free from Satan’s kingdom and be my Saviour and King. Thank You for dying for me.”

Review questions

- 1 How did God tell the wise men that His Son had been born? (God sent a new star.)
- 2 They did not think of Him as just a little baby. How did they think of Him? (He was a King.)
- 3 In what way is the Lord Jesus King? Where does He rule? (He is a heavenly King; King over all.)
- 4 Where did the wise men go to find out exactly when the King had been born? (Jerusalem.)
- 5 Herod asked the Jewish leaders where the king would be born. Where did they find the answer? (In the Old Testament; in God’s Word.)
- 6 The Bible talks about two kingdoms in this world. One is the Kingdom of the Lord Jesus. What is the other one? (The kingdom of Satan.)
- 7 How can a boy or girl change from the kingdom of Satan to the Kingdom of Jesus? (The Lord Jesus is the only One who can rescue him/her from Satan’s kingdom.)
- 8 When the wise men found Jesus, what two things did they do? (They worshipped Him and then gave Him their treasures.)
- 9 How can a person who has trusted in Jesus worship Him? (By taking time to think of His greatness and power and love; by thanking Him for being so great and good; by showing reverence to Him.)
- 10 Why did the wise men not go back to Herod to tell him that they had found King Jesus? (Herod wanted to kill Jesus and so God warned the wise men in a dream not to go back to Herod.)

CTU

Review game

Crazy eggs

Play this game as you played Mystery Points (page 22) but use slips of paper with funny actions; eg, pat your head and rub your stomach, do ten jumping jacks, touch your toes.

When a child answers a question correctly, he pulls a slip from the bottom of the carton. His entire team then does the action together.

Continue until all questions have been answered.

If desired, this game can also be played without dividing into teams.

Alternative review game

Journey

You could use two camels travelling across the desert (like the wise men used), or two teams of dogs pulling a sled, or two racing cars.

Preschool review game

Crazy eggs

Follow the instructions above or place slips of paper in coloured plastic eggs.

Use preschool questions from lessons 1-3.

You might also want to spend time in worship, singing praise songs and praying sentence prayers to thank and honour God. You might have children complete the thought: "Dear God, I think You are wonderful because ..."

Three or four children could also come up and read worship verses from the Psalms.

Preschool review questions

- 1 How did God use the special star in the sky? (To show the wise men where to find the King.)
- 2 Where did the wise men find the promised King? (At a house in Bethlehem.)
- 3 Who else was there with Jesus? (Mary and Joseph.)
- 4 What did the wise men do when they found the promised King? (They worshipped Him and gave Him gifts.)

Carry-over activity

True worship

Photocopy and cut out the tokens on page 68. Divide the children into groups and give each group one or more of the tokens.

Challenge the children to come up with ways to worship God while being involved in situations suggested by the tokens.

Carry-over activity

The Kingdom of Jesus

Photocopy the cross on page 69 for each child. Older children could cut it out themselves.

The cross can be folded into the following shapes:

- 1 **Cross**
We should love Him because He first loved us. He proved this by dying for us. (Romans 5:8.)
- 2 **Throne**
We should obey Him because He is King. (Psalm 145:1 and Colossians 3:23-24.)
- 3 **Present**
We should worship Him. This is the best gift we can give Him. (Romans 12:1-2.)

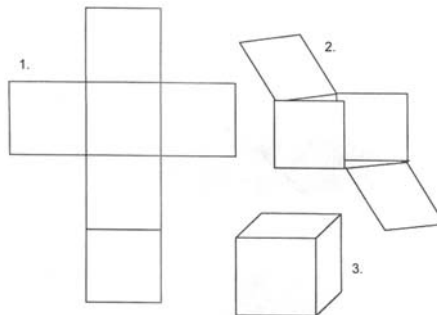

On one side the children could write the following:

Are you in the Kingdom of Jesus Who died for you?
If you are ... love Him.
obey Him.
worship Him.

Lesson 4

The Lord Jesus Christ as a child

Scripture for teachers

Matthew 2:19-23

Luke 2:40-52

Central truth

The Lord Jesus was a child

Application

Unsaved: Compare your life with His and you will see how sinful you are

Saved: You should follow His example

Memory verse

“For in that He Himself has suffered, being tempted, He is able to aid those who are tempted” Hebrews 2:18

Visual aids

◆ Flashcards: 3-5, 4-1, 4-2, 4-4, 4-5 and 4-6

Or

◆ Figures: 26, 28, 29, 31 and 32

◆ Backgrounds (optional): Outdoor scene, modest interior scene, plain background, outdoor scene and temple scene

And

◆ Cut out a picture of a child (eg from a magazine), trace the outline on a piece of card and add the words “The Lord Jesus was a child”

Carry-over activity

◆ For role-plays, see page 41 (or adapt the situations)

And/or

◆ Strips of ribbon - about 23 cm long for each child

◆ Velcro

◆ Fine marker

Lesson outline

Introduction

“Get up ... go back to the land of Israel”

Progression of events

- 1 Mary, Joseph and child leave Egypt
- 2 They go to Nazareth *CT*
- 3 Jesus helps in carpenter’s shop *CTS*
- 4 He is taught the Word of God
- 5 He goes to the synagogue *CTS*
- 6 Twelve years old, Jesus goes to Jerusalem
- 7 He goes to the temple
- 8 He asks many questions
- 9 He gets left behind
- 10 Mary and Joseph discover He is missing
- 11 They return to the temple

Climax

- 12 Mary - “Why have You done this to us?”
- 13 Jesus - “I must be about My Father’s business” *CTS*

Conclusion

- Family returns to Nazareth *CT*
- Lord Jesus is obedient to Mary and Joseph
CTS, CTU

Flashcard 3-5

Lesson

“Get up,” the angel said. “Take the little child and His mother and go back into the land of Israel. Those who are planning to kill Him are dead.”

The Bible does not tell us how long Joseph and Mary and the young boy Jesus were in Egypt before there was another message from the angel. This was the third time the angel talked to Joseph in a dream.

Scene 1

Optional background: Outdoor scene.

Again the family prepared for a trip.

Place Mary, Joseph and Jesus (26).

Would they go to Nazareth, where they lived before the baby was born, or to Bethlehem? Joseph decided on Bethlehem. But as they came into the area, Joseph heard some bad news. Herod’s son was the new king. He was just as mean and cruel as his father! Joseph wondered what he should do. God told him what to do.

“Don’t stop here,” was the warning. “Go to Galilee.”

Remove Mary, Joseph and Jesus (26).

CT

Nazareth was in Galilee, so the family went back to Nazareth. The Lord Jesus was still a little child, we don’t know for sure what age He was by this time. Like any other child He had to learn to walk and talk. He had to learn to read and write. I’m sure He played games with other children in Nazareth. He was four years old, six years old, nine years old - or whatever age you are. It is wonderful that the Son of God was once a child like you, for this means that He understands you. He knows what makes you happy and sad. He understands your problems, your fun and laughter, your tears when you get hurt. Don’t think, “Nobody understands how I feel” - the Lord Jesus Christ was a child and He understands.

Scene 2

Optional background: Modest interior scene or plain board. Place Mary, Joseph and Jesus (26).

Joseph went back to work in the carpenter’s shop. There the little boy, Jesus, grew up. He learned to be a carpenter (Mark 6:3). Joseph would have taught Him to pound a nail without hitting His finger. He would have learned to saw a board along a straight line. Most of the things He did were those any boy His age would have done. But, there was one way in which this boy, Jesus, was very different. He never sinned. He never lied to His mother or to Joseph or to anyone else. He was never mean to His little brothers and sisters. He never made fun of anyone or cheated at a game. If Joseph asked Him to do something He did not want to do, He never stamped His foot and talked back. He never stormed out and slammed the door.

CTS

Christian boy and girl, do you want to know how to live for God at home? Think of how the Lord Jesus lived when He was your age and follow His example. He, the Son of God Who had become a child, willingly obeyed Mary and Joseph. He knew God's Law and He kept it. He knew that God had said, "Honour your father and your mother" (Exodus 20:12) and He obeyed that command. Your mother and father will begin to notice that you belong to Jesus Christ if you obey them.

You will be different from your friends - they disobey, if they think it will not be found out, or if their parents are not around. But if you follow the example of the Lord Jesus, you will obey. You will go to bed when they tell you. When they say you're not allowed out to play, you won't sneak out, nor will you grumble and complain.

If you love the Lord Jesus, think of the times you find it hardest to obey and ask God today, "Please help me to be obedient at home, just as the Lord Jesus was."

While Jesus was growing up, Mary and Joseph must have been very careful to teach Him the Word of God (Old Testament). The Bible tells us very little about Jesus as a boy. It does say, "... the Child grew ..." (Luke 2:40). Other books tell us that children over six years of age had to go to school in those days. Their teachers were called Rabbis. With about twenty-five other students, the Lord Jesus may have stood or sometimes sat on the floor, while the rabbis taught the Old Testament, the Word of God. The children memorised much of the Old Testament.

Every Sabbath day He no doubt went to the synagogue, which was the place of worship, something like our churches. He gladly went to the House of God. Remember if He is your Saviour, He is also your example. In what way can you follow His example in this matter?

Allow children to respond.

Do you ever think, "I don't want to go to church," or "Church is boring; why can't I go fishing instead?" The Lord Jesus went to God's House without complaints, and you should too. Sometimes it is hard to understand everything you hear there. Ask God to help you understand more of it. He will, and you will learn something more about Him, as you listen carefully.

Remove all figures.

Scene 3

Optional background: Plain background.

There were many times during the year when the Jewish people worshipped God in a special way. They called these times of special worship feasts. Joseph and Mary surely explained these to God's Son, Jesus.

CTS

Flashcard 4-1

Show Jerusalem on a map.

Passover was one of three feasts held each year that all men were required to attend. See Exodus 11-12.

Flashcard 4-2

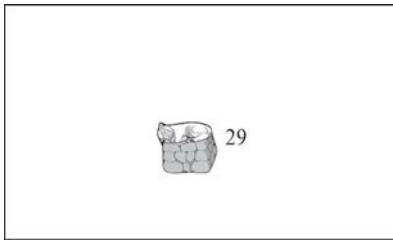

See Exodus 12:24-27

Point out the route from Nazareth to Jerusalem on a map. Children enjoy looking at maps.

Flashcard 4-1

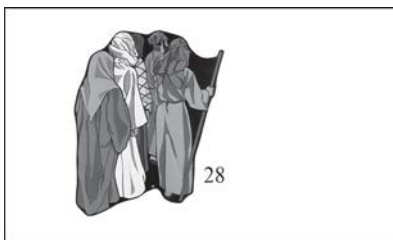

Let preschoolers stand up and walk slowly "up the hill to Jerusalem" and sing a praise song as the people go up to the temple to worship. You could use "Praise Him, Praise Him, all you little children" or another song that they are familiar with.

At least once a year, Joseph would go to Jerusalem. (Jerusalem was near to Bethlehem where Jesus was born.) Joseph would always go at the time of the Passover Feast.

The Passover was the most important of the feasts and had a wonderful meaning to the Jewish people. It was a reminder that once they had been slaves of a cruel king in Egypt. But, God wanted them to be free. The king thought he was greater than God and he would not allow them to go free. To make the king willing to free them, God said the oldest child in every family would die on a certain night.

Place lamb on altar (29).

He asked His people to kill a lamb and put the blood of the lamb over and around the doors of their houses. God said, "When I see the blood of the lamb I will pass over you," meaning that He would pass over that house and none would die there (from Exodus 12:13). So, that night was called the "Passover". God set a time for the people to celebrate the Passover every year. It was a time when the people remembered in a special way how God had kept them safe. Perhaps Mary explained to Jesus, "When you are old enough, we will take you with us to Jerusalem for the Passover."

Jesus never begged or teased to persuade His parents to let Him go. He just obeyed and waited. He knew when He was eleven years old that the next year He could go. He must have been very excited as He counted the months. How slowly they seemed to go by. Finally, He was twelve. Now He counted the weeks and then the days.

At last the day came to leave Nazareth for Jerusalem.

Remove lamb on altar (29).

Scene 4

Optional background: Outdoor scene. Place crowd (28).

Jesus was not surprised to see many people going to Jerusalem. Other boys His age were with their parents too. As the men, women and children travelled south, more people joined them. Sometimes the men walked in one group, the women in another and the children went on together. The trip took several days. At night they must have camped near the roadside. It was a custom that as they were coming near to Jerusalem, the crowd quoted the words from the Psalms. The Lord Jesus had learned much of God's Word. He must have joined the others in repeating the Psalms. Looking around at the hills and mountains they said, "I will lift up my eyes to the hills - from whence comes my help? My help comes from the Lord, who made heaven and earth" (Psalm 121:1-2).

The crowd kept their eyes toward the city for the first sight of the temple. Suddenly someone called, "Look! There it is!" Again they

praised God by repeating a Psalm. "I was glad when they said to me, 'Let us go into the house of the Lord.' Our feet have been standing within your gates, O Jerusalem!" (Psalm 122:1-2).

The boy Jesus was surely thrilled at His first glimpse of God's temple. From a distance it could be seen standing higher than all the other buildings. Much of it was marble and much was overlaid (covered) with gold and silver. It was beautiful. There were so many things to see and there was so much to learn.

Remove crowd (28). Place lamb on altar (29).

As lambs were killed at the temple, the people were reminded of the first Passover. The blood of the lambs was caught in basins and sprinkled on the altar (rather than around doors, as at the first Passover). The blood was offered as a sacrifice for sin.

After the blood was sprinkled on the altar, lambs were roasted and family groups ate the Passover meal. There were many things to do in Jerusalem with other special meals and times of worship at the temple. Jesus was fascinated by the temple. It was God's temple, His Father's house. He was greatly interested in the different things that went on there. Do you think He knew then that when He grew to be a man He would die on a cross, offering His blood as a sacrifice for sin? Do you think He knew that after His offering for sin, no more animal sacrifices would be made? The verse in our Bible was not yet written which says, "... the blood of Jesus Christ His Son cleanses us from all sin" (1 John 1:7), nor was the verse, "Christ died for our sins ..." (1 Corinthians 15:3 - see also Hebrews 10:10,12,19). Anyway, the Lord Jesus had many questions He wanted to ask.

Scene 5

Optional background: Temple scene.

The teachers at the temple looked so wise. Surely they could answer His questions. He must talk with them, and He watched for a time when He could do that.

Place Jesus with teachers (31).

It's not wrong to have questions! Perhaps you have questions about something you have heard from God's Word. Perhaps you really want to trust Jesus Christ as your Saviour but you are not sure how. Wait in your seat when others have gone and I will show you, from God's Word, the answers to your questions.

The Lord Jesus was very interested in what He heard. While He sat asking and listening, the crowd from Nazareth left for home.

Remove all figures.

Flashcard 4-2



Flashcard 4-4

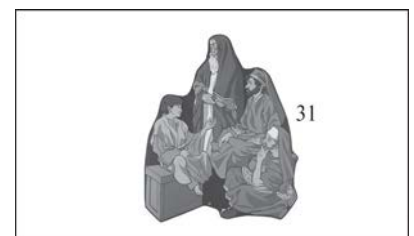

Scene 6

Optional background: Outdoor scene. Place crowd (28).

Joseph must have travelled with the men. He may have thought, "Jesus is with Mary." Mary must have walked with the women. She may have thought, "Jesus is with Joseph." When they met one another they said, "He's probably with those running ahead of the group." Even when Jesus did not join them for lunch they said, "He must be eating with His cousins or with the families of some friends."

Place Mary and Joseph (32).

Toward evening they began to ask about Him. "Have you seen Jesus? Did anyone see our boy? Has He not been with the other boys in the crowd? Where is He?"

Remove crowd (28).

It was clear to them now - Jesus was not to be found in the crowd.

Mary and Joseph hurried to Jerusalem as fast as they could go. How troubled they were! Had they failed God in taking care of His Son? Their hearts were filled with fear, thinking about all that might have happened.

Reaching Jerusalem they searched all the places they had been, especially the temple.

But the temple was so big and had many, many rooms. Surely by now others were helping in the search. The Lord Jesus had been missing for three days! They went up one hall and down another. Into one room and out of another. Mary went around a corner with Joseph behind her and ... there He was, sitting among the teachers!

For just a moment they may have watched.

Scene 7

Optional background: Temple scene. Place Jesus with teachers (31).

The Lord Jesus was listening to the teachers, and they were listening to Him. He was asking them questions, and they were questioning Him. "What did this mean?"

The Bible says, "... all who heard Him were astonished at His understanding and answers" (Luke 2:47).

"My Son," Mary cried, "why have You done this to us? Your father and I have searched for You. We have been so worried."

"But, why did you search for Me?" He asked. "Do you not understand that I must be in My Father's house, and doing His work?"

In this gentle way they were reminded that His real Father was God.

Even Mary and Joseph were going to have to learn that the Lord Jesus had come to Earth to do what God, His Father wanted. He was going to do all that His Father had planned for Him and nothing

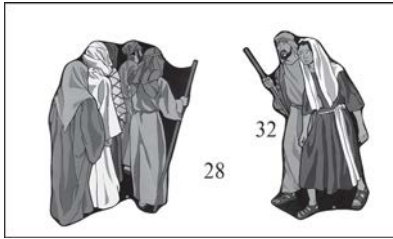

Flashcard 4-5

Have preschoolers walk around searching for Jesus. Ask questions like, "Where is Jesus? Have you seen Him yet? Where can He be? Did you find Him yet?" and then in unison, "Let's go back to Jerusalem to find Him."

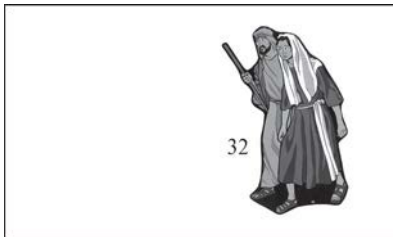

Flashcard 4-6

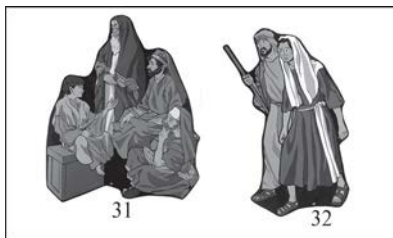

Children would enjoy handling a scroll representing those used in the temple at that time.

would move Him from that. If you belong to the Lord Jesus, you can learn from Him that you too should always obey God first.

Let me tell you about John and his friends who planned to go to the swimming pool on Saturday.

“Why don’t we ask that new boy, Thomas. He has no friends at all.”

John’s friends said, “Oh, no - we’ll not ask him.”

“I don’t like him.”

“He can’t swim well.”

“He’s far too quiet.”

“He has a dirty face!”

John couldn’t get Thomas’s sad face out of his mind. What should he do if he is going to follow the example of the Lord Jesus, and obey God before anyone else?

Allow children to suggest what he should do.

Christian children should become more and more like Jesus Christ.

Remove all figures.

He and Mary and Joseph returned to Nazareth. Mary watched her Son day after day and thought and thought about the things that had happened at Jerusalem.

The Lord Jesus would soon be a teenager. The Bible says He was always obedient to Mary and Joseph (Luke 2:51). He didn’t say, “I don’t see why I shouldn’t go - everyone else can go.” He wasn’t a rebel at home. If you are a teenager, or when you become one, be like the Lord Jesus. The Bible says, “Children, obey your parents in all things, for this is well pleasing to the Lord” (Colossians 3:20).

We know very, very little about the Lord Jesus during His teenage years. But the Bible tells us He grew taller and stronger, God really blessed Him and the people of Nazareth thought well of Him - although they didn’t know who He really was!

If He is your Saviour, ask Him to help you to follow His example - to be like Him by obeying God before anyone else, by attending God’s house, by being obedient at home.

If you do not know Him, His pure sinless life shows you how sinful you are. His life shows you that you need to have your sin taken away and your life changed by Him. It may be that as we’ve looked at the Lord Jesus as a child, you’ve seen how different and bad you are. You see now that your life does not please God. We learned that Jesus Christ can put you right with God. He Himself said, “I am the way, the truth, and the life. No one comes to the Father except through Me” (John 14:6). He is the only way to God. Won’t you trust Him to do that for you now? Then He’ll help you to live in a way that will please Him - He will make you more and more like Himself.

CTS

CT

CTS

CTU

Review game

Button points

Using a marker and masking tape, label the inside of each cup of an egg carton with point values. Drop a button in the carton and close it.

Divide into teams and ask questions alternately of each.

When a child answers correctly, he may shake the carton, open the lid and look under the button to find out how many points his team earns.

The team earning the most points wins.

Review questions

- 1 For a third time an angel spoke to Joseph. The angel told him to take Jesus and Mary on a journey. From where and to where? (From Egypt back into the land of Israel.)
- 2 Why could they go now? (Those who had been planning to kill Him [Herod] were now dead.)
- 3 Like other boys, the Lord Jesus learned to do a job. Which one? (He learned to be a carpenter.)
- 4 In what way was Jesus totally different from other children? (He never sinned.)
- 5 For what feast would Joseph go with the other people to Jerusalem? (Passover Feast.)
- 6 Why did the people keep this feast? (They remembered the time when they had been slaves in Egypt and God had set them free. They had killed a lamb and put the blood over and around the doors of their houses. God said, "When I see the blood of the lamb I will pass over you," meaning that He would pass over that house and none would die there.)
- 7 After the visit to Jerusalem, Joseph and Mary could not find Jesus. Where was He and what was He doing? (In the temple listening to the teachers and asking them questions.)
- 8 When Joseph and Mary asked Him why He had stayed there, what did He reply? ("Why did you search for Me? Do you not understand that I must be in My Father's house, and doing His work?")
- 9 We read that the Lord Jesus obeyed His earthly parents. Give three examples of how He would have obeyed.
- 10 Give me one example of how a boy or girl who loves the Lord should obey God in each of these situations.
 - (a) In the morning before going to school.
 - (b) In the evening.
 - (c) On Good News Club night.

Preschool review game

Button points

Follow the instructions above but don't divide into teams.

Use preschool questions from lessons 1-4.

Preschool review questions

- 1 Why did Mary and Joseph go to Jerusalem? (To celebrate Passover.)
- 2 What did Passover remind the people of? (The time when God saved His people from the plague that killed firstborn children in Egypt.)
- 3 When Mary and Joseph went home from the celebration, where did Jesus stay? (In the temple.)
- 4 What are some ways you can obey your Heavenly Father? (Obey your parents, be kind, share, etc.)

*Carry-over activity***Role play**

Use the following role-plays and situations to help the saved child to follow the example of the Lord Jesus.

- 1 Needed: Two children.

One takes the part of the “Christian” child. The other child says, “Tomorrow in the test, please sit beside me and let me see your answers.”

Discuss together, “What would Jesus do and say?”

- 2 Needed: Three girls, doll, doll’s pram and ball.

Mother says to the “Christian” child, “Take your little brother [the doll] to the park in the pram. Don’t leave him or he will be frightened and cry.”

Another child with a ball comes and says, “Leave the baby a while. Come and play with me.”

Discuss together, “What would Jesus do?”

- 3 Mother calls child to get up quickly and get dressed.

Discuss together, “What would Jesus do?”

- 4 In the evening Dad tells boy, “Get on with your homework. Don’t turn on the TV until you’re finished.”

A football match is due and he is tempted to turn on the TV.

Discuss together, “What would Jesus do?”

*Carry-over activity***What would Jesus do?**

Have the children make a little bracelet with the initials “W W J D” (what would Jesus do?).

Have available little strips of ribbon (light blue or green, for example) of about 23 cm long. The children could stick little pieces of velcro on the ends to make a fastener. With a fine marker the children could print the letters. (You should test the marker on the ribbon beforehand.)

Give this explanation to the children: “If you are a Christian and love the Lord Jesus, wear the bracelet. When you are tempted to do wrong, or when you are tempted not to do what is kind and helpful, look at the bracelet and think, “What would Jesus do?” He can help you to do what He would have done.

Lesson 5

The Lord Jesus Christ in temptation

Scripture for teachers

Matthew 3:1-4
Matthew 4:1-11
Mark 1:4-12
Luke 3:1-16,21-22
Luke 4:1-13

The order of the temptations is from Matthew

Central truth

Jesus Christ was tempted in every way just as we are
- yet was without sin

Application

Unsaved: As the central truth is only applied to the
saved child, you could have an
“evangelistic spot” (see page 44) at
another point in your programme

Saved: Trust Him to help overcome temptation

Memory verse

Review Hebrews 2:18

Visual aids

- ◆ Flashcards: 5-1, 5-2, 5-3, 5-4, 5-5 and 5-6
- ◆ For flashcard 5-5, cut three circles of plain paper to cover the circles on the visual aid. The paper could be attached with blu-tac and removed at the appropriate points in the text (marked as Flashcard 5-5a, 5-5b and 5-5c).

Or

- ◆ Figures: 4, 18, 19, 20, 33, 34, 35, 36, 37, 38 and 39
- ◆ Backgrounds (optional): Plain background, river scene and barren outdoor scene.

And

- ◆ Visualise the central truth on two symbols of an arrow (representing temptation) and a shield (Christ’s sinlessness) - see page 70.

Carry-over activity

- ◆ Write out each of the Bible verses for a child to read aloud.
- ◆ Photocopy the take-home sheet (page 71) for each child.

Lesson outline

Introduction

There was a fierce battle raging! *CTS*

Progression of events

- 1 John preaches by Jordan
- 2 He tells of the One Who will come
- 3 The Lord Jesus comes
- 4 He is baptised by John
- 5 The Holy Spirit comes in form of a dove
- 6 Voice - “This is My beloved Son ...”
- 7 Lord Jesus is led into the wilderness
- 8 Satan - “Make these stones bread” *CTS*
- 9 Lord Jesus - “Man shall not live by bread alone” *CTS*
- 10 Satan tempts Lord Jesus to throw Himself down from pinnacle
- 11 Lord Jesus - “You shall not tempt the Lord your God” *CTS*

Climax

- 12 Satan offers Him the kingdoms of the world
- 13 Lord Jesus - “You shall worship the Lord your God” *CTS*

Conclusion

Satan leaves Him for a time
Angels minister to Lord Jesus *CTS*

Gospel activity

Change of heart

Use the following outline to explain the Gospel briefly and clearly. Alternatively, give your own testimony or have an interview with your hostess or helper as they give their testimony.

Place symbols vertically as indicated below.

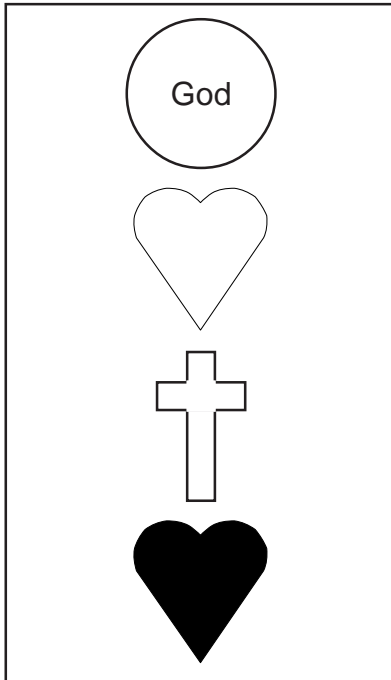

For preschoolers use Romans 3:23 and John 3:16. Examples of sin might include hitting other children, not sharing toys or tearing up something someone has made.

Place symbol for God (3).

Can you imagine living in a place where no one is ever hurt or sad and where nothing bad ever happens? God lives in a place like that! It's called Heaven. Heaven is a much better place than Earth because it doesn't have something you have in your heart.

Place dark heart (5).

The Bible says, "The heart is deceitful above all things, and desperately wicked" (Jeremiah 17:9). Your heart (the real you, the part of you that thinks and feels) is sinful and wants to do wrong. That's why you disobey your parents, think mean thoughts and do other wrong things that break God's laws. Because you sin, you deserve God's punishment for sin, which is separation from Him forever in a place of suffering and sadness. You can't go to Heaven with sin in your heart.

Place clean heart (9.)

How can you have your sin forgiven so your heart will be clean before God? There's only one way.

Place cross (7).

The Bible says, "The blood of Jesus Christ His Son cleanses us from all sin" (1 John 1:7). Jesus, God the Son, came to Earth to die for your sin. Jesus is holy (perfect) and He never did anything wrong. He came to die for the wrong things you have done. When He suffered, bled and died on the cross, He paid the whole price for your sin so you could be forgiven and go to Heaven someday. The only way you can be forgiven of your sin is by trusting Jesus as your Saviour, the One Who can save you from your sin and make you ready for Heaven. Are you ready for Heaven? Listen carefully during our lesson as we talk more about that.

Lesson

There was a fierce battle raging! You wouldn't have seen it or heard it for it was deep inside Philip. Just three months earlier he had trusted Jesus Christ as his Saviour. His brothers called him names, sometimes they even hid his Bible.

His Mum and Dad said, "We don't believe that you need to be saved. You'll soon grow out of that."

It was so hard to be a Christian that Philip felt like giving up. He knew the Lord Jesus had saved him, and he did love the Lord. But it was so hard at home, Philip felt torn in two.

"Does anyone understand?" thought Philip in despair. "Can anyone help me?"

The answer to his questions is a big YES. Listen to this - we have One Who "was in all points tempted as we are, yet without sin" (Hebrews 4:15). That is what we read in the Bible about the Lord Jesus Christ. He understands Philip's problem. He was tempted to give up but He didn't. He can help you for He went through all kinds of tests and temptations but He never sinned. Last time we heard that even as a child He never sinned. Now He was no longer a child. He had worked for some years with Joseph.

Scene 1

Optional background: Plain board. Place Jesus (34).

One day news reached Nazareth and the carpenter's shop.

"A man named John is preaching beside the Jordan River and great crowds are coming to hear him. He is baptising people in the river. He is called 'John the Baptist'."

This man was the son born to Zacharias and Elizabeth, the couple whom Mary had visited before Jesus was born! The Lord Jesus knew it was now time for Him to leave the carpenter's shop. He went to the Jordan River to meet John the Baptist.

Remove Jesus (34).

Scene 2

Optional background: River scene. Place John the Baptist (33) and crowd (20).

John knew the Word of God and was now a great preacher. All kinds of people came to hear him - young and old, rich and poor, leaders or rulers, and many ordinary people. They came from near and far, even from the city of Jerusalem.

People wondered, "Is John the Christ, the Promised One?"

"No," John said, "One is coming Who is so great that I'm not good enough to get down and help Him take off His shoes."

Place Jesus (34).

Preschool lesson - you may wish to skip this lesson and instead review the first four lessons. Use the appropriate flannelgraph figures for the lessons, allowing the children to identify the right figures. Use simple review questions as you teach, most of the questions being about the story, but some on teaching and application - eg "Why was the baby

CTS

called Jesus? Why did He come to Earth? Where was He before?"

Preschool tips are included in the sidebars for those who choose to use this lesson.

Flashcard 5-1

When people were baptised by John, it showed repentance (turning from sin) not forgiveness.

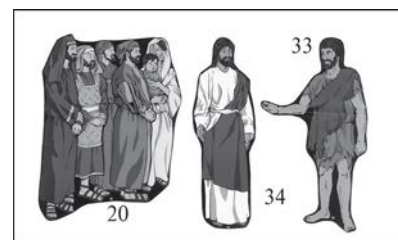
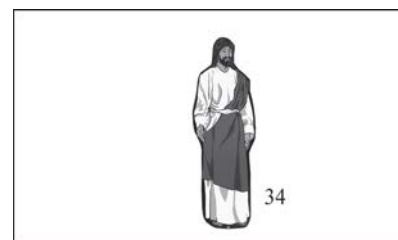

Flashcard 5-2

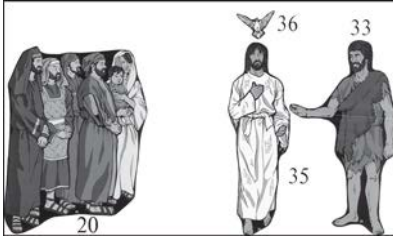

Flashcard 5-3

Soon afterwards that One did come. The crowd didn't know who He was, but John knew Him. When the Lord Jesus stepped out of the crowd asking John to baptise Him, John could not believe it.

“Shall I baptise You?” he asked. “You should baptise me.”

“This is the right way for now,” the Lord Jesus answered and, as He stepped into the water, John baptised him.

Replace Jesus (34) with figure 35.

As the Lord Jesus came out of the water a wonderful thing happened! God the Holy Spirit, taking the form of a dove, came and rested on the Lord Jesus.

Place dove (36).

A voice from heaven was heard!

“This is My beloved Son, in Whom I am well pleased” (from Mark 1:11 and Luke 3:22).

Place triangle (4).

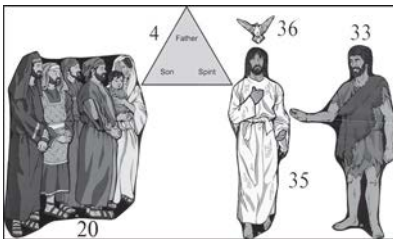

It was the voice of God the Father! How perfect! God the Father and God the Holy Spirit agreeing with God the Son that He was doing right. This shows us again that while there is only One God, He is three persons.

Remove triangle (4).

John the Baptist heard and understood. Someone else heard and hated every bit of that wonderful happening. Do you know who that was?

Allow the children to answer.

It was Satan, the devil, God's enemy.

It is always the plan of the enemy of God to spoil everything God does. He was the one who tempted the first man and woman to doubt God's Word and disobey God. When God sent the Saviour, the Lord Jesus, into the world, this enemy was the one who put the idea into King Herod's heart to try to kill the Lord Jesus as a baby. He planned to keep the Saviour from dying on the cross for the sin of the world. If God's Son did not die and pour out His blood on the cross, your sin (and mine) could not be forgiven. Satan wanted very much to get Jesus Christ to sin ... then He could never save others.

Flashcard 5-4

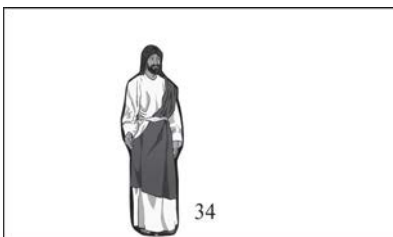

Remove all figures.

Scene 3

Optional background: Barren outdoor scene or plain board. Place Jesus (34).

It was just after the special day when Jesus was baptised and God spoke from heaven. The Holy Spirit led the Lord Jesus into the wilderness to be tempted by the devil. The wilderness was a rocky, sandy place. No one lived there. The Lord Jesus was alone with wild

animals. For forty days He was there with nothing to eat. He was very hungry! And Satan was ready to tempt Him.

Place stones and bread (37).

“If you are the Son of God,” the devil said, “Tell these stones to turn into bread” (from Matthew 4:3).

It was as if the enemy was saying, “Your Father isn’t taking care of You. He is permitting You to be hungry. That’s not very good of Him. You don’t need His help. You can take care of yourself.”

Often Satan does the same kind of thing today. He tries to get those who belong to God to think that God doesn’t really care for them. He might have made Philip (of whom we heard at the beginning) think, “If God loved you He wouldn’t let these things happen.” If you love the Lord Jesus, Satan will put those thoughts in your mind too.

Never forget that your Saviour knows exactly what you’re going through. Up in Heaven He is praying for you, that you will be kept from sin. He knows what temptation is like and knows exactly what to ask God the Father for you. He can, and does, help by praying for you all the time (Hebrews 7:25).

Looking at those stones all around Him, the Lord Jesus saw how much they looked like little loaves of bread. He could have picked one up and turned it into bread in His hands. He was very hungry. This bread would satisfy His hunger. But more than anything else the Lord Jesus wanted to obey His Father. Obeying Satan would be sin. He did not give in to this temptation of Satan.

The Lord Jesus had hidden God’s Word in His heart. He used the Word of God to win over Satan.

“It is written,” the Lord said, “Man shall not live by bread alone, but by every word that comes from the mouth of God” (from Deuteronomy 8:3 and Matthew 4:4).

Food will keep your body alive but the real you, that will live forever, needs the Word of God. If you obey the word God has spoken, He will take care of you. It is important to know what God has said in His Word. This will help you say “no” to the ideas Satan puts in your mind. The Lord Jesus refused to obey Satan. God’s enemy failed. If you have trusted the Lord Jesus as your Saviour, Satan may whisper things like, “It’s too hard to follow Jesus Christ - give up,” or, “If God really loved you, things wouldn’t be so hard - give up.” You don’t have to obey him! He is a strong enemy, but Jesus Christ is stronger. He defeated Satan and, with His help, you can too. He had far harder struggles than you will ever have, and He defeated Satan each time! He can help you. When those wrong ideas come into your mind, ask the Lord Jesus to help you say “no” to Satan.

Place angels (38).

See Luke 4:1-13 and Mark 1:12-13. The wilderness (desert) was probably located in the

Flashcard 5-5a
(see page 43)

lower Jordan Valley. Children will enjoy seeing this area on a map.

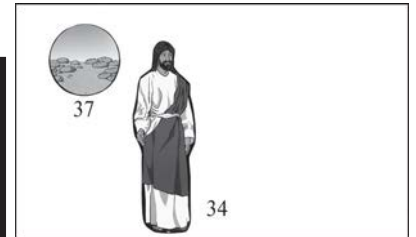

CTS

Children may enjoy role-playing the passages where Satan tempts Jesus. You may want to script this for them or have it marked in your Bible for them to read.

Pass around a stone to help children remember this part of the story.

Turning stones to bread wasn’t sin, but obeying Satan is always sin.

Jesus did not sin in any way, whether by actions or word or inner desire. He defeated Satan the way all believers can - by using the Word of God.

CTS

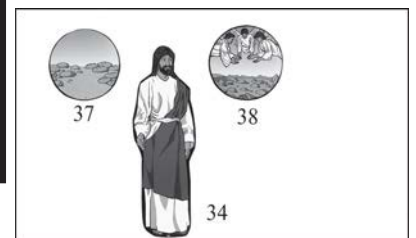

Flashcard 5-5b

If possible, show a picture of how the temple was positioned above the Kidron Valley to help children visualise how high up the pinnacle was.

Satan tried to suggest Psalm 91:11-12 as a licence to do what otherwise might be considered sinful.

But Satan had more planned. He took the Lord Jesus to the top of the temple.

“If you are God’s Son, throw yourself down,” Satan said, “for it is written, ‘He shall give His angels charge over you. In their hands they shall bear you up, lest you dash your foot against a stone’” (from Psalm 91:11-12 and Matthew 4:6).

Satan, too, spoke words from the Bible. But, he did not say them correctly. He left out the part that said the angels would “keep you in all your ways.” God has given His angels a command to care for us when we are in God’s way, doing what He wants us to do. The devil tried to make that verse say what it does not really mean. He was saying, “Let’s see how powerful God is. Surely He will use His power to protect You.”

The Lord Jesus looked down from the top of the temple to the streets of Jerusalem. There were always crowds around the temple. If He threw Himself down and landed without being hurt, it would prove to the crowds that He was protected by God’s power. People would follow Him. It was a temptation. But, it was not God’s way. The Lord Jesus said “no” to that temptation with another verse of Scripture which He had memorised.

“It is written,” He said, “‘You shall not tempt the Lord your God!’” (from Deuteronomy 6:16 and Matthew 4:7). He trusted God’s Word which He had hidden in His heart. The Lord Jesus did not sin!

CTS

If you love the Lord Jesus Christ, Satan will try to get you to disobey God in order to be popular. Perhaps you and your friends are late for class. They say, “We’ll say we didn’t hear the bell.” What do you do? Do you refuse to tell a lie and perhaps lose their friendship? It’s very difficult to do the right thing. The Lord Jesus knows just how difficult it is. He can help you obey God. Remember He prays for you and also He is right there with you when you are tempted. The One Who never gave in to Satan will help you not to give in.

Place world (39).

Satan still did not give up. He took the Lord Jesus to a very high mountain. By looking around you could see far and wide for miles and miles, and it was beautiful.

“Do you see these kingdoms of the world?” Satan asked. “All of this I will give to you, if you fall on your knees and worship me!” (from Matthew 4:8-9).

Have you ever looked at something that would make you popular and wanted that thing? The Bible says those kingdoms looked beautiful. The Lord Jesus could have ruled over them that day. But, would the Lord Jesus ever worship Satan instead of His Father, God? He came to do His Father’s will. He would obey God.

Flashcard 5-5c

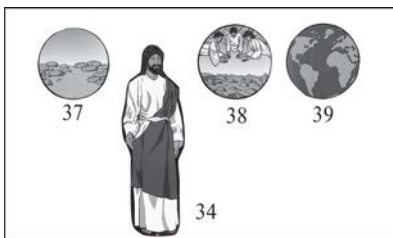

“Get away from me, Satan,” the Lord Jesus Christ said. “It is written, ‘You shall worship the Lord your God, and Him only you shall serve’” (from Deuteronomy 6:13 and Matthew 4:10). Again the Lord answered the devil with the Word of God.

Remove all figures.

If you are a Christian, I’m sure Satan has tried to get you to disobey God in order to get something you really want - “Copy that homework and you’ll get good marks,” or, “Take the money for ice-cream from your mother’s purse, she’ll never miss it.” It is hard to say “no”. The Lord Jesus knows how hard it is and He has shown us how to be strong against Satan. Each time the Lord answered Satan from the Bible. That is one reason why it is important for you to get to know God’s Word and learn parts of it. When Satan comes with his ideas you’ll know they are wrong and you’ll be able to say, “The Bible says ...”

When Satan says, “Copy,” or “Take that money,” how could you answer him from the Bible?

Allow children to respond.

Isn’t it wonderful that each time the Lord Jesus answered Satan with the Word of God.

At last Satan left Him for a time.

Scene 4

Optional background: Barren outdoor scene.

It was then that something very wonderful happened.

Place Jesus (34) and angels (18 and 19).

Angels came and waited upon (or served) the Lord Jesus. I think they brought Him food - more than just bread! I think they spoke words of encouragement to Him too. He didn’t need to throw Himself from the temple, for the angels to care for Him. He just needed to say “no” to Satan and “yes” to God, and God sent the angels to show His love and care.

We should be very thankful to the Lord Jesus Christ, that He was willing to be tempted. Because He Himself suffered when He was tempted, He is able to help those who are being tempted (Hebrews 2:18). When you find it hard to obey God, when Satan tries to get you to do wrong, don’t say, “Nobody understands”. The Lord Jesus understands. He prays that you will be kept from sin. He is with you to help you defeat Satan. He will help you remember God’s Word and use it against the devil.

Before we leave Club, quietly tell the Lord about a struggle you’ve been having, ask for His help. You will discover for yourself that, just as the Bible says, He is able to help those who are being tempted.

CTS

You might want to compile a list of verses to help children with different areas of temptation. (The carry-over activity gives a practical suggestion of how to do this.)

Flashcard 5-6

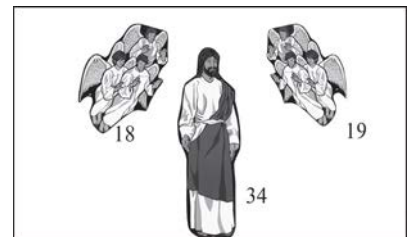

CTS

Review game

Cracked

Play this game as you played Button Points (page 40) but label four of the egg carton cups with Xs and the other eight with point values.

When a child answers a question correctly, he may shake the carton, open the lid and look under the button to find out how many points his team earns. If the button lands on an X his turn is over. If it lands on points, he earns them for his team.

The child may continue to shake the carton and earn points as long as he wants, but if the button lands on an X he must stop and lose all points earned for that round.

The team earning the most points wins.

Review game for Lesson 6

To prepare for lesson 6, ask children what game they would like to play next week.

Review questions

- 1 What was the name of the man who baptised Jesus? (John.)
- 2 Where did John baptise Jesus? (In the Jordan River.)
- 3 At the baptism of Jesus, God the Son, what did God the Father do? (God the Father spoke from Heaven and said, "This is My beloved Son, in Whom I am well pleased.")
- 4 What did God the Holy Spirit do? (God the Holy Spirit, taking the form of a dove, came and rested on the Lord Jesus.)
- 5 Complete the sentence. There is one God, but ___ persons. (Three.)
- 6 Who is the enemy of God and of all God's children? (Satan, the devil.)
- 7 Where was Jesus tempted and for how long? (In the wilderness, for forty days.)
- 8 What was the first temptation? (Satan tempted Jesus to turn stones into bread.)
- 9 What did the Lord Jesus use to overcome the temptation? (He quoted the Word of God.)
- 10 How does the Lord Jesus up in Heaven help Christians when they face temptations? (He is praying for them, that they will be kept from sin.)
- 11 What would you answer if somebody said, "The Lord Jesus could not possibly understand what it feels like to be tempted"? ("He knows what temptation is like because He too was tempted.")
- 12 The Lord Jesus can help in our temptations for two important reasons. One reason is that He too was tempted. What is the other reason? (He never sinned.)

Carry-over activity

Using God's Word

Jesus overcame Satan by using God's Word that He had memorised. Use the following to show the children how they can learn to overcome temptation, also by using God's Word.

Give one of the following verses to each of six children. Read out the list of temptations below and the child with the appropriate verse reads it out, to give God's answer to the temptation.

- 1 "Lies are not important sins. Go ahead and tell that little lie!" ("Therefore, putting away lying, 'Let each one of you speak truth'" - Ephesians 4:25a)
- 2 "You are too weak to overcome temptation." ("... He [the Holy Spirit] who is in you is greater than he [Satan] who is in the world" - 1 John 4:4b.)

- 3 “Nobody is looking. Go ahead and do that wrong thing!” (“For He [God] looks to the ends of the earth, and sees under the whole heavens” - Job 28:24.)
- 4 “Jesus is far away up in Heaven and it doesn’t matter to Him if you cheat or not. Go ahead!” (“... He [the Lord Jesus] always lives to make intercession [pray] for them” Hebrews 7:25b.)
- 5 “It’s smart to disobey your parents!” (“Children, obey your parents in the Lord, for this is right” - Ephesians 6:1.)
- 6 “Take that money!” (“You shall not steal” Exodus 20:15.)

Photocopy the take-home sheet (page 71) for each child.

Lesson 6

The Lord Jesus calling disciples

Scripture for teachers

John 1:29,35-51

Mark 1:16-20

Mark 2:13-17

Luke 6:12-16

Central truth

Jesus Christ is calling men and women, boys and girls to be His disciples

Application

Unsaved: Obey His call when He speaks to your heart

Saved: Continue to be a faithful disciple

Memory verse

“If anyone desires to come after Me, let him deny himself, and take up his cross daily, and follow Me”

Luke 9:23

Visual aids

◆ Flashcards: 4-2, 4-3, 6-1, 6-2, 6-3, 6-4, 6-5 and 6-6

Or

◆ Figures: 20, 30, 33, 40, 41, 42, 43, 44, 45, 46, 47, 48 and 49

◆ Backgrounds (optional): Seaside scene and outdoor scene.

And

◆ Visualise the central truth on footprints (see page 72)

◆ You may want to make wordstrips for the words “trust”, “tell”, “leave”, “learn” and “obey”, and use them as you teach this lesson.

Carry-over activity

◆ Chalk, or wool, or marker and whiteboard or large sheet of white paper

And/or

◆ Photocopy the three footprints on page 73 for each child

◆ Scissors, glue and coloured card

Lesson outline

Introduction

“Look! There is the Lamb of God!”

Progression of events

- 1 Andrew and John follow the Lord Jesus *CTU*
- 2 They stay with Him for that day
- 3 Andrew brings Simon to Him
- 4 Simon becomes a disciple
- 5 Philip becomes a disciple
- 6 Nathanael becomes a disciple *CTU*
- 7 One tells another about the Lord Jesus *CTS*
- 8 Peter, Andrew, James and John work on their nets
- 9 The Lord Jesus - “Follow Me ...”
- 10 They leave their nets and follow Him
- 11 The Lord Jesus calls Matthew *CTU, CTS*
- 12 The Lord Jesus prays

Climax

He chooses “the twelve”

Conclusion

He teaches them *CTS*

He sends them out *CTS, CTU*

Create simple flashcards, or draw each of the symbols below on a dry erase board.

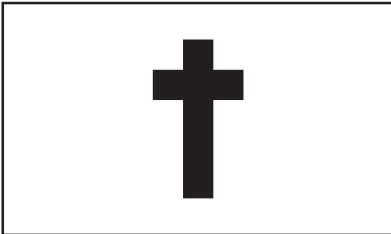
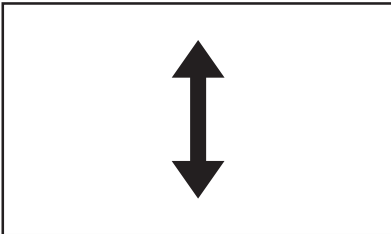
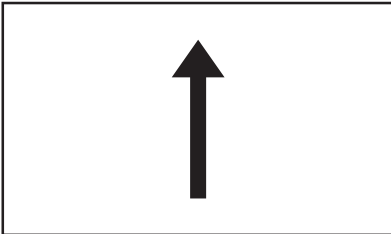
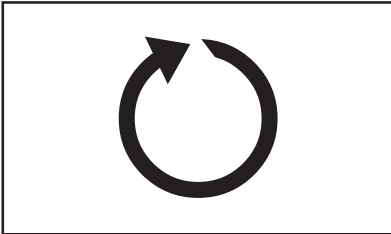

Gospel activity

Life after death?

Have you ever thought about death? Most children don't think about it until someone they love dies. What do you suppose happens after death?

Let children share.

Show flashcard with X.

Some children think nothing will happen after they die. Their body will be buried and they just won't exist anymore. But the Bible teaches that you have a body and a soul. One day your body will die but your soul will live forever.

Show flashcard with circular arrow.

Some children know they have a living soul but believe their soul will come back to Earth as a different person or creature. That's called reincarnation. But God says in His Word, "It is appointed for men to die once, but after this the judgment" (Hebrews 9:27). Each of us will leave this life just once then face God and enter eternity.

Show flashcard with arrow pointing up.

Some children know they have a living soul and only one life on Earth, but they think they will automatically go to Heaven someday. Is that true?

Let children share.

Show flashcard with arrows pointing up and down.

The truth is some will go to be with God in Heaven and some will be separated from Him forever in Hell. The Bible says "all have sinned" (Romans 3:23) and "the wages of sin is death" (Romans 6:23). All of us are sinners. We have all done wrong things that break God's law and God says everyone who sins deserves death (separation from God forever in Hell).

Show flashcard with cross.

But God loves you and He made a way for your sin to be forgiven. He sent His Son, the Lord Jesus, to Earth to die for your sin. The Bible says, "For Christ also suffered once for sins, the just for the unjust, that He might bring us to God" (1 Peter 3:18). Jesus died in your place. He took the punishment you deserved so He could bring you to God. Then He came back to life again. If you haven't yet trusted Jesus as your Saviour, you can do that today. Listen carefully during the lesson as we talk more about it.

Lesson

Scene 1

Optional background: Seaside scene. Place John the Baptist (33), crowd (20) and Jesus (40).

“Look!” he said, and everyone did look. “There is the Lamb of God,” John said, “the One who will take away the sin of the world” (from John 1:29).

Some of John’s followers must have stopped to think about that. “The Lamb of God”. They would have thought of the lambs on the altar at the temple in Jerusalem. One after another the lambs were killed and blood was shed (flowed from the animal’s body). Those lambs died for sins. But they did not take away sins. God had planned it that way until His Son, the Lord Jesus Christ, came as the Lamb of God.

Briefly replace Jesus (40) with figure 30.

His blood, shed on the cross, would take away sin. After that it would not be necessary for even one more lamb to die for sin, nor for sacrifices of any kind. “The sin of the world,” John said. Yes, all the world has sinned; and that means you and me. It was for our sin, all our disobedience to God, that Jesus died.

Remove all figures.

Scene 2

Optional background: Seaside scene. Place Andrew (41) and John (42).

Two of John’s disciples were with him the next day, when the Lord Jesus walked by.

Again John said, “There is the Lamb of God” (from John 1:36).

Immediately those two disciples left him and began to follow Jesus. They wanted to learn more from Him, the Lamb of God. They were going to be His disciples, or followers. This makes us think of what a disciple of Jesus Christ is. A disciple is someone who has come to trust the Lord Jesus as the Lamb of God, Who died for their sin. Jesus Christ is still the Lamb of God, Who made the last sacrifice for sin for ever. He is still calling men and women, boys and girls to be His disciples. Obedience to His call means trusting Him, as the One Who died for your sin, and depending on Him to take away your sin and make you pure before God for ever.

Place “trust” wordstrip.

This is how you become a follower, or a disciple of the Lamb of God. Trusting the Lord Jesus is the beginning of a life of obedience to Him.

Place Jesus (40).

The Son of God turned toward them. “What are you looking for?” He asked.

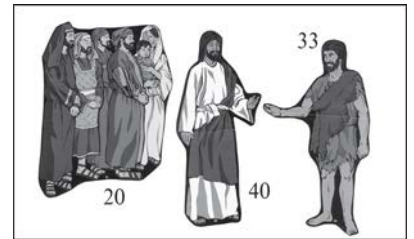

Flashcard 4-2

Flashcard 4-3

Flashcard 6-1

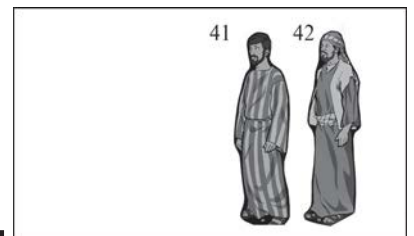

CTU

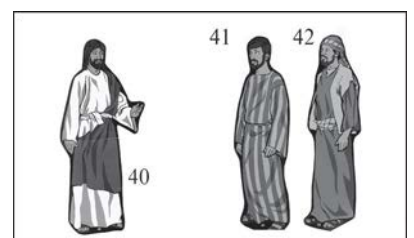

Messiah means "The Christ" or "The Promised One".

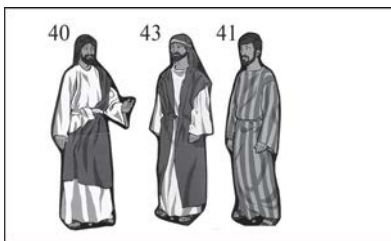

Flashcard 6-2

In Bible times names told what a person was like. The name Peter means "rock". Because he had chosen to follow Jesus, Simon would be a changed person who had strength in the Lord.

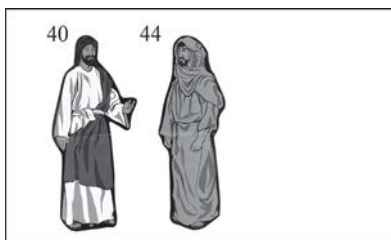

Flashcard 6-3

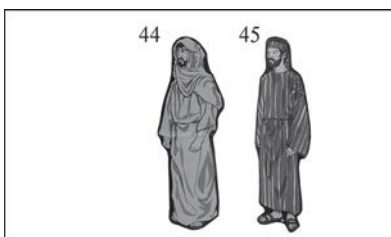

"Teacher, where do you live?" they asked Him.

"Come and see," the Lord Jesus said.

And they did. They stayed with Him all the rest of that day. The two disciples who had followed John were now learning from the Lord Jesus. What wonderful things those two men, Andrew and John (not John the Baptist, but another John) must have learned that day.

Remove all figures.

Scene 3

Optional background: Outdoor scene. Place Andrew (41).

Andrew could hardly wait to share the news. His brother Simon must hear about this Man.

"Simon!" he called. "We have found the Messiah!"

Place Peter (43).

No wonder Andrew was excited. For as long as he could remember, those who loved God talked about the coming of the Messiah. They had looked for Him and hoped for the time He would come. Now He was here! Quickly Simon joined Andrew and together they hurried to find the Lord Jesus, the Son of God.

Place Jesus (40).

"You are Simon," the Lord Jesus said. "Your name will be Peter."

And Simon, who was to be called Peter, was just as excited as Andrew had been. Perhaps Andrew and Peter told their friend Philip, for Philip was from their town.

Remove all figures.

Scene 4

Optional background: Outdoor scene. Place Jesus (40) and Philip (44).

The next day the Lord Jesus found Philip.

"Follow me," He said.

And so Philip became a disciple of the Lord Jesus. Philip too was excited and he found Nathanael.

Remove Jesus (40). Place Nathanael (45).

"We have found the Promised One," he said, "the One Moses and the prophets wrote about! It is Jesus, the son of Joseph, Who comes from Nazareth!" (Philip may not have understood about Jesus being the Son of God).

"Nazareth!" Nathanael exclaimed. "Can anything good come from there?"

"Come and see," Philip said.

Place Jesus (40).

When Jesus saw Nathanael, He said, "Here is truly an honest man."

"How do you know me?" Nathanael asked.

"Before Philip called you, I saw you under the fig tree," Jesus said. It was as if He was saying, "I knew you before you ever thought of Me."

He knows you too, just as you are. And He loves you! He is calling you to turn from your sin and come to Him. He's calling you to be His follower, just as He called Nathanael. Perhaps you know that He is asking you to follow Him; you want to obey, but you are not sure how to become His follower. If you want to ask me about that at the end of Club, I'll be here by the flannelgraph board and will be glad to show you from the Bible how to become a disciple of the Lord Jesus. Come and talk with me.

"Teacher," Nathanael said, "You are God's Son! You are the King of Israel!" (or the King of the Jews).

Even though Philip had spoken of Him as the son of Joseph, Nathanael believed Him to be the Son of God. Andrew brought his brother Simon; Philip brought his friend Nathanael. Being a disciple of Jesus Christ means telling others about Him.

Place "tell" wordstrip.

Have you a brother or a friend you could tell about Him? Perhaps they ask you why you read the Bible, or why you won't laugh at and make fun of the old man down the street. Have you taken the chance to tell them that you belong to Jesus Christ? You could invite them along here next week, so they can hear God's Word too. The Lord Jesus is still calling people to be disciples. Being a disciple means that you are not ashamed to let others know you belong to Jesus Christ. Philip told Nathanael.

The Lord Jesus must have smiled as He said to Nathanael, "You will see greater things than this."

Remove all figures.

We have learned of five men who became disciples of the Son of God. Can you remember their names? They were eager to learn more about Him. They knew His words were very important. Whenever they could be free from their work, they wanted to be with Him.

Scene 5

Optional background: Seaside scene.

Andrew, Peter and John were fishermen. John's brother, James, who worked with them in the fishing business, also heard about the Lord Jesus Christ. After they met the Son of God, they must have talked about Him more than anything else.

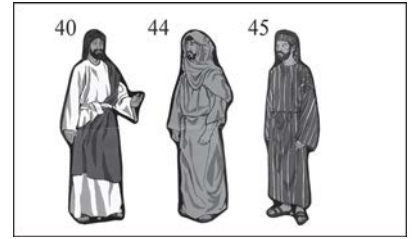

CTU

CTS

Children would enjoy handling a fishing net.

Flashcard 6-4

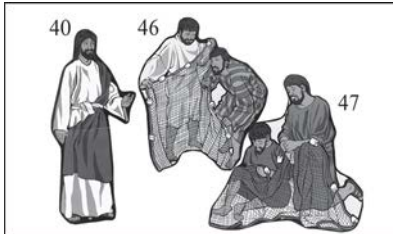

Children could role-play James and John as they follow Jesus and leave their father and other fishermen behind.

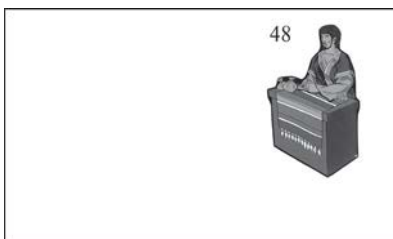

Place Andrew and Peter (46) and James and John (47).

One morning the fishermen were getting their nets ready for work. Peter and Andrew threw their nets into the water and pulled them back again, washing out the sand and tiny stones. John and James were by the boat with their father, mending some tears in their nets.

Place Jesus (40).

Looking up, they saw the Lord Jesus walking along the shore. Every time they saw Him, they felt happy. He came right over to where they worked.

“Follow Me,” He said, “and I will make you become fishers of men” (from Mark 1:17).

The men knew that this call to follow was a very special one. This meant, “Leave your work; stop fishing for fish. Just come and learn about Me. Let me teach you about God. Let Me send you out to bring other men (or people) to Me.”

How do you think they felt? Perhaps their feelings were kind of mixed up. It was wonderful to be invited (or chosen) to follow Him - but, leave their work? Perhaps they thought about how hard they had worked for other fishermen until they had earned enough money to buy their own boats out on Lake Galilee; and in the morning they brought many fish to the shore. As they unloaded their boats, sorting the little fish from the big ones, people were waiting to buy the fresh fish. No more fishing every day? No more selling fish? Where would they get money to take care of their families?

But the fishermen did not think about those things very long, for the Bible says “immediately” Peter and Andrew left their nets and followed Jesus (Mark 1:18). James and John left their father and walked away from their fishing business (Mark 1:19-20). The Lord Jesus had chosen them and they would follow.

Remove all figures.

Scene 6

Optional background: Outdoor scene.

The Lord Jesus said that God the Father knows what we need, and if we give Him first place in our life, He will take care of our needs (Matthew 6:31-33). The disciples were willing to trust the Lord for that. They knew God loved them and they believed that He would care for them.

It may have been hard for those fishermen to imagine that Jesus could love everyone. They often walked by the office of Matthew, the tax collector. Most people hated him. Tax collectors were usually dishonest.

Place Matthew (48).

They often took money from the taxpayers that did not belong to them. Day after day, Matthew sat in his office by the shore of Lake Galilee. One day the Lord Jesus was walking by that office. People crowded around Him.

Place crowd (20) and Jesus (40).

Andrew and Peter and other disciples were probably there, too. But, the Lord Jesus just looked at Matthew.

“Follow Me,” He said.

Right away Matthew left his desk and his money and followed!

Peter and John left their boats, Matthew left his tax collecting for being a disciple of Jesus Christ always means leaving something.

Place “leave” wordstrip.

For you it might not mean leaving home or school but it will mean leaving everything you know to be wrong in your life. Bad language, bad company, a bad habit, bad temper ... you know what it is. Are you prepared to turn away from that? It may mean changing your beliefs and ideas, so that you believe what the Bible teaches. You know what you would have to leave.

Perhaps you are a disciple, but other things have become more important than the Lord Jesus. If there is a good TV programme, do you miss Sunday school? When your friend asks you to go and play with him instead of going to Good News Club, do you miss Club? Ask God to forgive you and to help you be a more faithful follower of the Lord Jesus Christ.

Now we know about seven disciples whom He called to work for Him. Let's name them - Andrew and Peter, James and John, Philip and Nathanael (who is sometimes called Bartholomew) and Matthew. The Lord Jesus wanted twelve men to send out in His work.

At the close of one Sabbath day the Lord Jesus went up on the mountain.

Remove Jesus (40).

The Bible says He went there to pray. He prayed all night. He was about to choose others to send out to work for Him. It was important that the right ones be chosen. So He talked with His Father about it all night.

Remove all figures.

In the morning when He came down from the mountain there was probably a large group of disciples (learners) waiting for Him. God's Word says, “He chose twelve” (Luke 6:13). We have already named seven. Now there were five others: Thomas, another James, Simon, Thaddeus and Judas Iscariot.

Flashcard 6-5

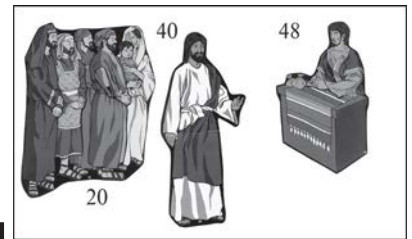

CTU

CTS

God uses ordinary people for EXTRAordinary work!

Flashcard 6-6

You may want to create wordstrips with the names of the twelve disciples.

Scene 7

Optional background: Outdoor scene. Place Jesus and disciples (49).

These men had never heard a teacher like the Lord Jesus Christ. They loved those times when, away from the crowds, they sat and listened to this wonderful teacher. The Lord Jesus spent a long time teaching His disciples about God and His ways. Sometimes they were very slow learners but He was patient with them, for learning from the Lord Jesus is very important for every disciple.

The Lord Jesus is still calling people to be His disciples. If you are His disciple, or if you become one, you will learn from Him. Of course, you can't sit out on the hillside with Him like this, but you learn from Him by reading the Bible. Every time God's Word is read or explained you should listen very carefully. If you are old enough to read the Bible for yourself, you should do that each day, especially if you belong to the Lord Jesus. If you'd like to talk to me about how to go about reading a little part of the Bible each day, ask me afterwards. Disciples are always learning from Jesus Christ.

Place "learn" wordstrip.

Even if you live to be very old, you still have lots more to learn!

After they had learned many things, the Lord Jesus Christ sent the disciples out to work for Him. They didn't say, "We don't want to go." They did what their Master said. They knew that being a disciple meant obeying Him.

Place "obey" wordstrip.

It means the same for you, if you are going to be His disciple. When you trust the Lord Jesus, the Lamb of God, to take away your sin, this is the beginning of a life of obedience to Him. You learn what He wants you to be like as you read the Bible, then you obey Him. You know God says, for example, "Children, obey your parents" (Ephesians 6:1). As a disciple you obey God by being obedient at home, even when you don't feel like it. You show that you are a disciple of the Lord Jesus Christ by obeying Him.

The Lord Jesus calls all kinds of people, and all kinds of children to be His disciples. In your heart today do you know that He is calling you? He is saying to you, "Follow Me." If you really want to be His disciple, speak to Him quietly in your heart, "Dear Lamb of God, thank You for dying for me. Please make me clean from all my sin and make me Your disciple."

Perhaps you are His disciple, but as you've learned about trusting, telling, leaving, learning and obeying, you realise there are some things in your life which have not been pleasing to your Master. Tell Him about it as we close, ask Him to forgive you and to help you be a better disciple.

You may want to have the children silently pray in their own words. Let them tell God what they are

giving Him. "Anything, anytime, anywhere" is a good reminder. You may want to make bookmarks to remind each child of his commitment.

Review questions

- 1 Why is Jesus called the Lamb of God? (Lambs died for sins. They were killed and the blood shed at the altar in the temple. Later Jesus would die to take away sins.)
- 2 Why did the two men with John the Baptist choose to follow Jesus? (They wanted to learn more from Him.)
- 3 How does a boy or girl today become a disciple of Jesus? (Trust in the Lord Jesus as the Lamb of God, Who died for their sin.)
- 4 Why did Andrew tell his brother Simon? (God had promised to send the Messiah and now that Andrew had found the Messiah he wanted Simon to meet Him too.)
- 5 What important thing did Andrew and Philip do, something that every disciple should also do? (They told others about Jesus.)
- 6 What did Jesus mean when He told the fishermen, "Follow me and I will make you fishers of men"? ("Leave your work; stop fishing for fish. Just come and learn about Me. Let me teach you about God. Let Me send you out to bring other people to Me.")
- 7 The four fishermen immediately left their boats and their jobs. Why was this a very important, maybe quite a hard decision to take? (For them following Jesus meant giving up their jobs.)
- 8 The first disciples were probably surprised when Jesus called Matthew to be a disciple too. Why were they probably surprised at this? (Matthew was a tax collector and most people hated tax collectors because they were usually dishonest.)
- 9 To become a disciple of Jesus you must be prepared to leave some things. What are they? (For example, bad language, bad company, a bad habit, bad temper.)
- 10 Sometimes even disciples of Jesus have to leave some things because they love Him best of all. Give me one or two examples.

Preschool review questions

- 1 Why is Jesus called the Lamb of God? (He gave His life for our sin.)
- 2 What did the men do when Jesus called them? (They followed Him.)
- 3 How can you follow Jesus? (Believe on Him as your Saviour and obey Him.)
- 4 What did Jesus do before He chose His twelve disciples? (He prayed.)

*Review game****Clubbers' favourite***

Play the game the children chose last week as their favourite, or choose one based on their reactions to previous games.

*Preschool review game****Preschoolers' favourite***

Choose a favourite from the previous lessons.

Use all the preschool questions from this lesson series.

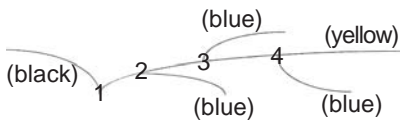

Carry-over activity

Which direction?

If possible draw the pattern with chalk lines on the floor (or put down lines of wool on the floor, or draw with marker on a whiteboard or large sheet of white paper).

Read the following scene to the children.

Jill comes to Good News Club for several weeks. In one class she hears about the Lamb of God who came to take away the sin of the world. She does not think much about it. She is rather inattentive and is not concerned about her sin. She leaves the club.

We are at point 1 in our diagram. In which direction is Jill going?

Allow the children to answer.

On the black line, going away from Jesus.

The same day Roger hears the Bible lesson. He realises that he has done many wrong things and displeased God. He wants the Lord to change him. When he goes home, he kneels by his bed and asks the Lord Jesus to forgive his sin and to change him. In which direction has he started out?

Allow the children to answer.

Yes, on the yellow line. He has become a disciple of Jesus.

Roger trusted the Lord Jesus some weeks ago. His best friend Angus at school has seen that Roger has stopped using so many bad words. He seems a much kinder person now.

Angus asks Roger, "How come you have changed so much?"

Roger is ashamed to tell him how the Lord Jesus has saved him and how he is now His disciple.

We are now at point 2.

In what direction has Roger gone?

Allow the children to answer.

Yes, off on the blue one. He is still a disciple of the Lord Jesus but not following as closely as he should.

A couple of days later, Roger sums up his courage and tells Angus how the Lord Jesus has changed his life. He invites Angus to the Good News Club. Now Roger is back on track again, isn't he? Let's take off the blue one.

Remove or rub off the blue one.

Roger loves football. Sometimes after school on Fridays some of the other boys from his class play 5-a-side football in the gym. Roger goes too but he leaves at 4.30 pm because the Good News Club starts at 5.00 pm.

Adjust the timetable to your own situation.

He knows that it is more important to go to the Good News Club to learn from God's Word, but this week he is tempted to stay for the football. He quickly asks for God's help and leaves the football and his friends.

We are now at point 3. Which way does he go?

Allow the children to answer.

Yes, on with Jesus. He wants to learn from Jesus and so he must sometimes leave other things behind.

Take off the second blue line.

Most nights Roger prays and reads a few verses from the Bible before he turns off the light and goes to sleep. Tonight he forgot to get his Bible before he got into bed. He feels too tired to get up and look for the Bible. He doesn't pray either.

We are at point 4. Which line is Roger following?

Allow the children to answer.

Yes, he had gone off a little on the blue track. He will need to remember tomorrow to read and pray and get on the right track again!

Carry-over activity

Following Jesus

Photocopy the three footprints on page 73 for each child. The children can cut out the footprints and mount them on coloured card.

If you are a disciple of the Lord Jesus, cut out these three footprints. Stick them on a card and keep it in your Bible.

Jesus Christ is God the Son

Carry-over activity - lesson 1

If you are a Christian, tell the Lord Jesus every day that you love Him and want to obey Him.

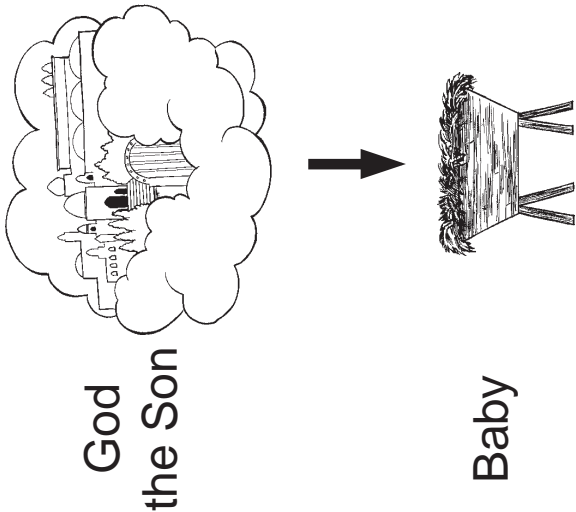

God the Son

Baby

I have obeyed God by ...

1. _____
2. _____
3. _____
4. _____
5. _____

If you are a Christian, tell the Lord Jesus every day that you love Him and want to obey Him.

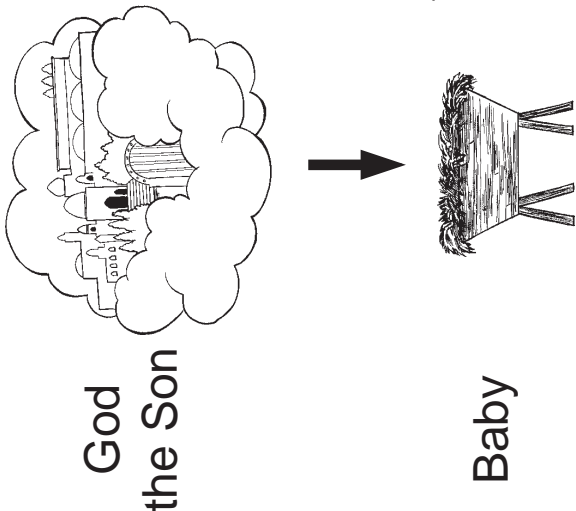

God the Son

Baby

I have obeyed God by ...

1. _____
2. _____
3. _____
4. _____
5. _____

Jesus Christ is God the Son

Carry-over activity for preschoolers - lesson 1

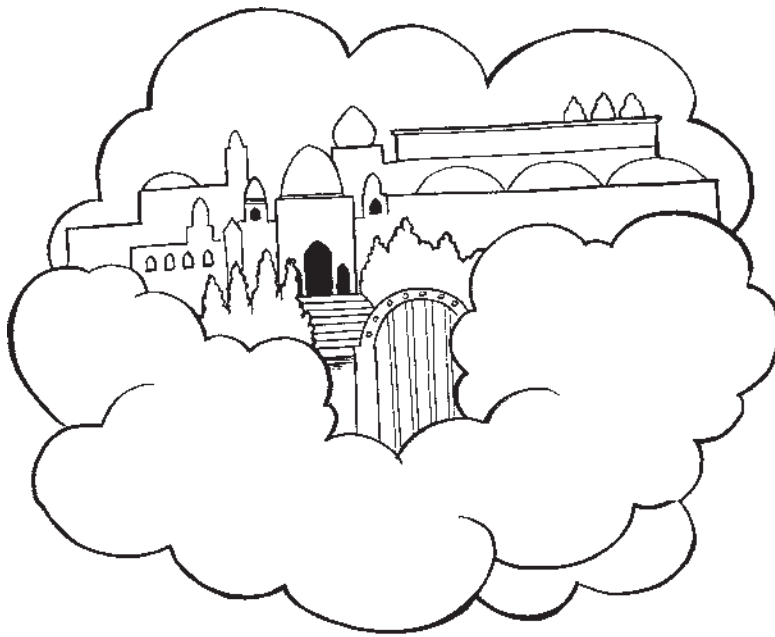

God
the Son

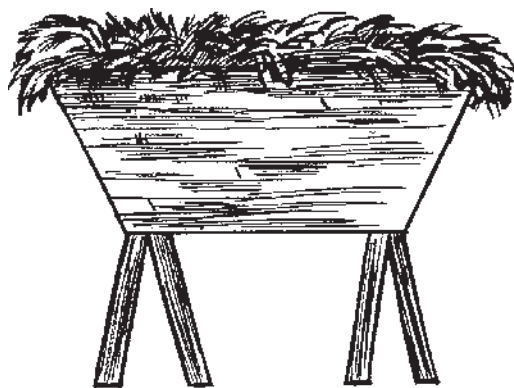

Baby

The only Saviour from sin

Central truth - lesson 2

The Lord Jesus
came into
the world
to be the
only Saviour
from sin

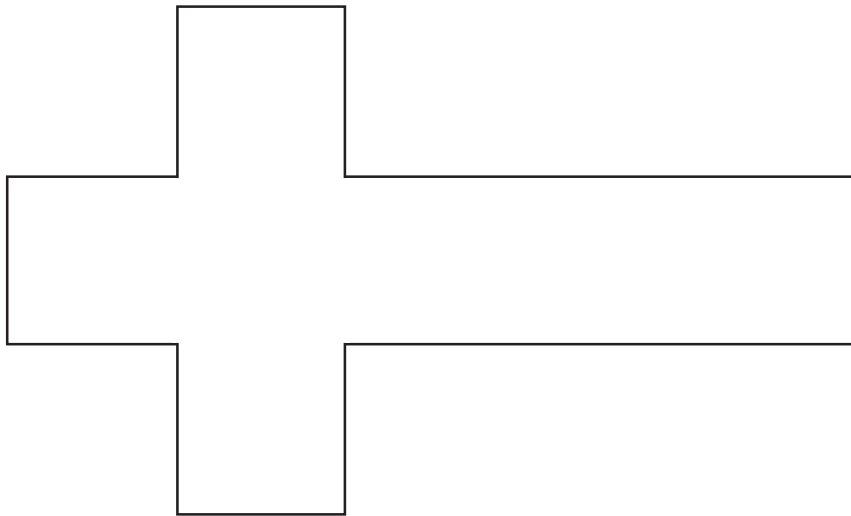

Jesus Christ was born King

Central truth - lesson 3

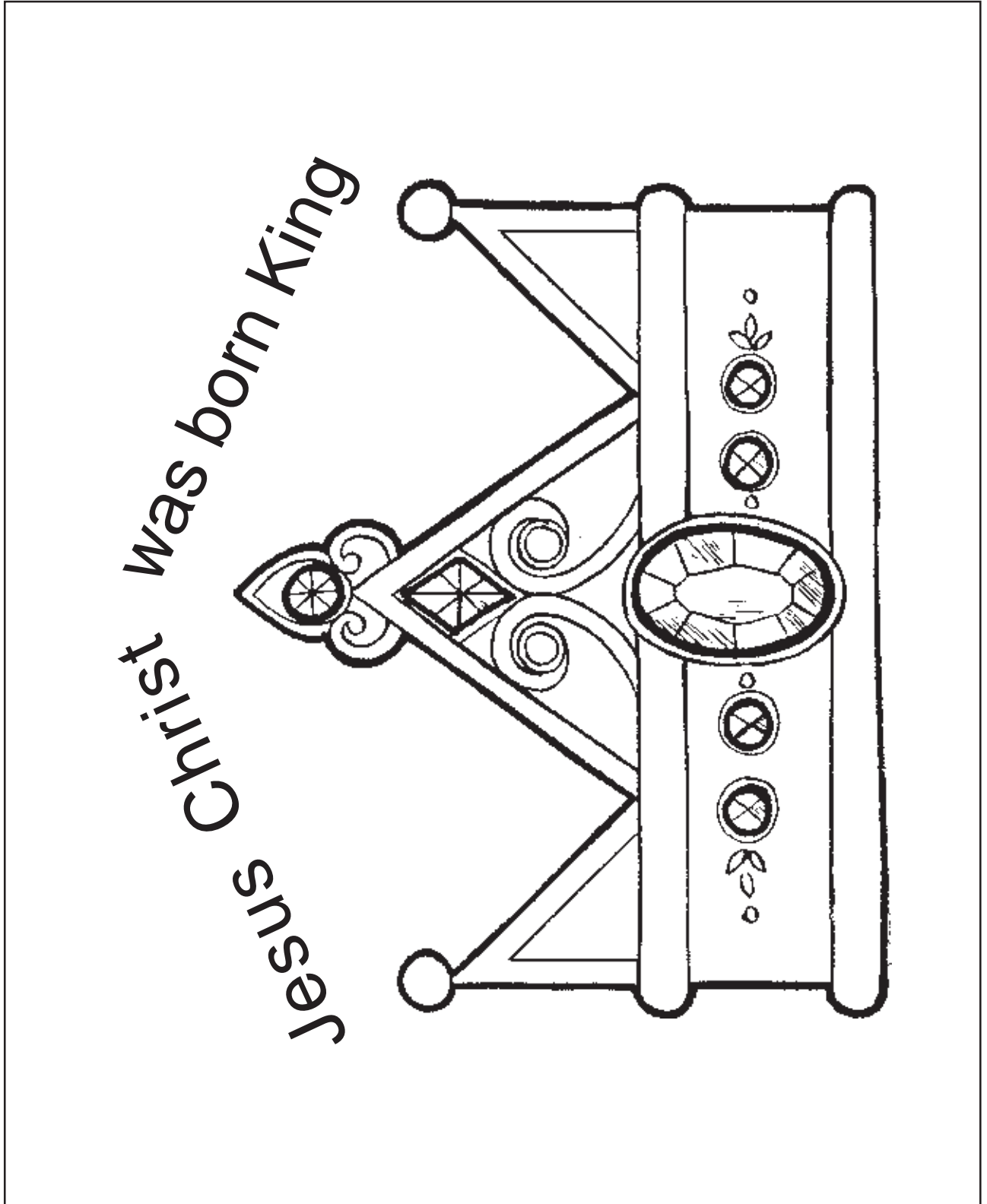

True worship

Carry-over activity - lesson 3

In school	At church
With friends	At mealtime
Playing sports	At home
With money	In prayer

The Kingdom of Jesus

Carry-over activity - lesson 3

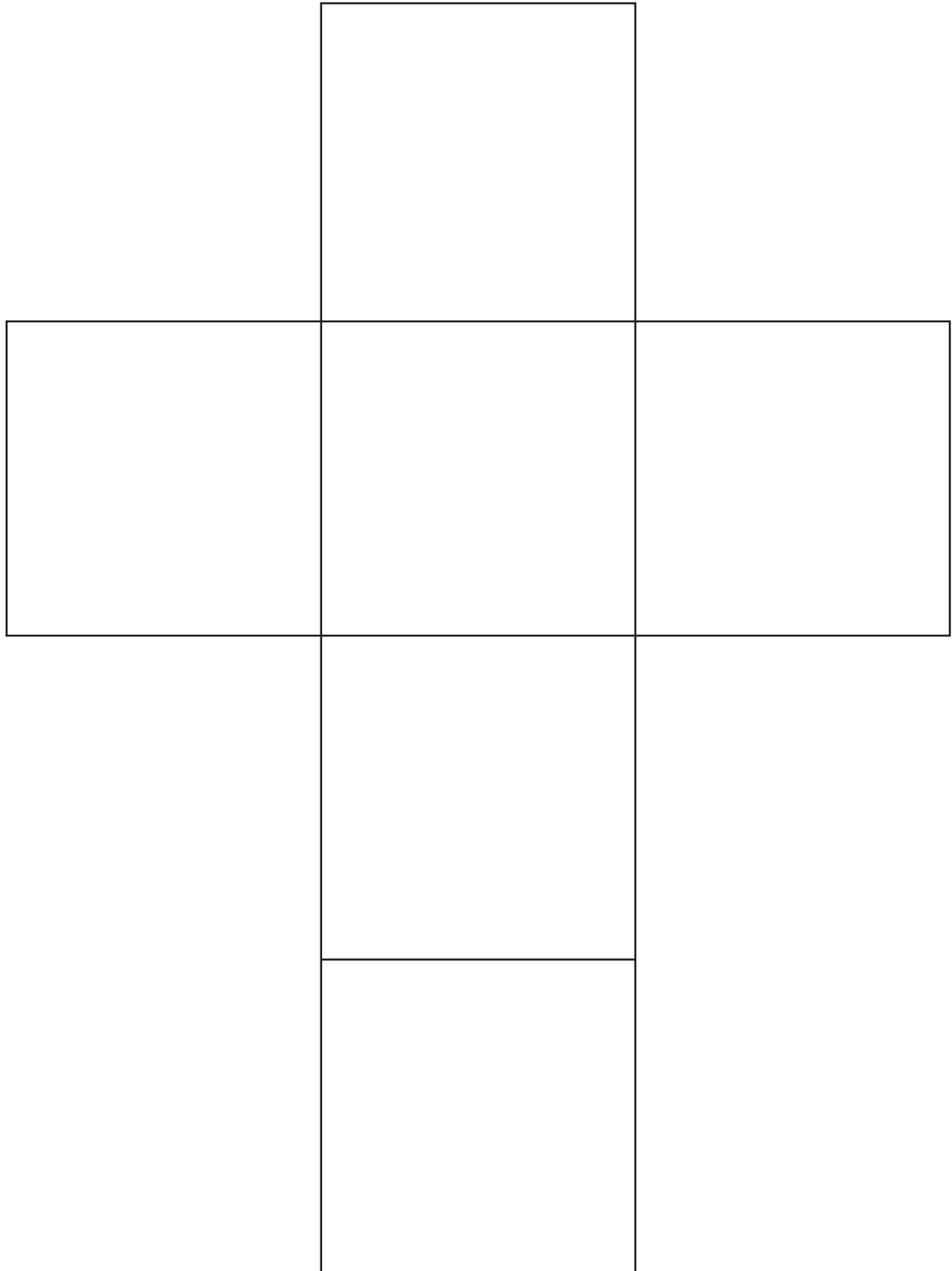

Jesus was tempted just as we are

Central truth - lesson 5

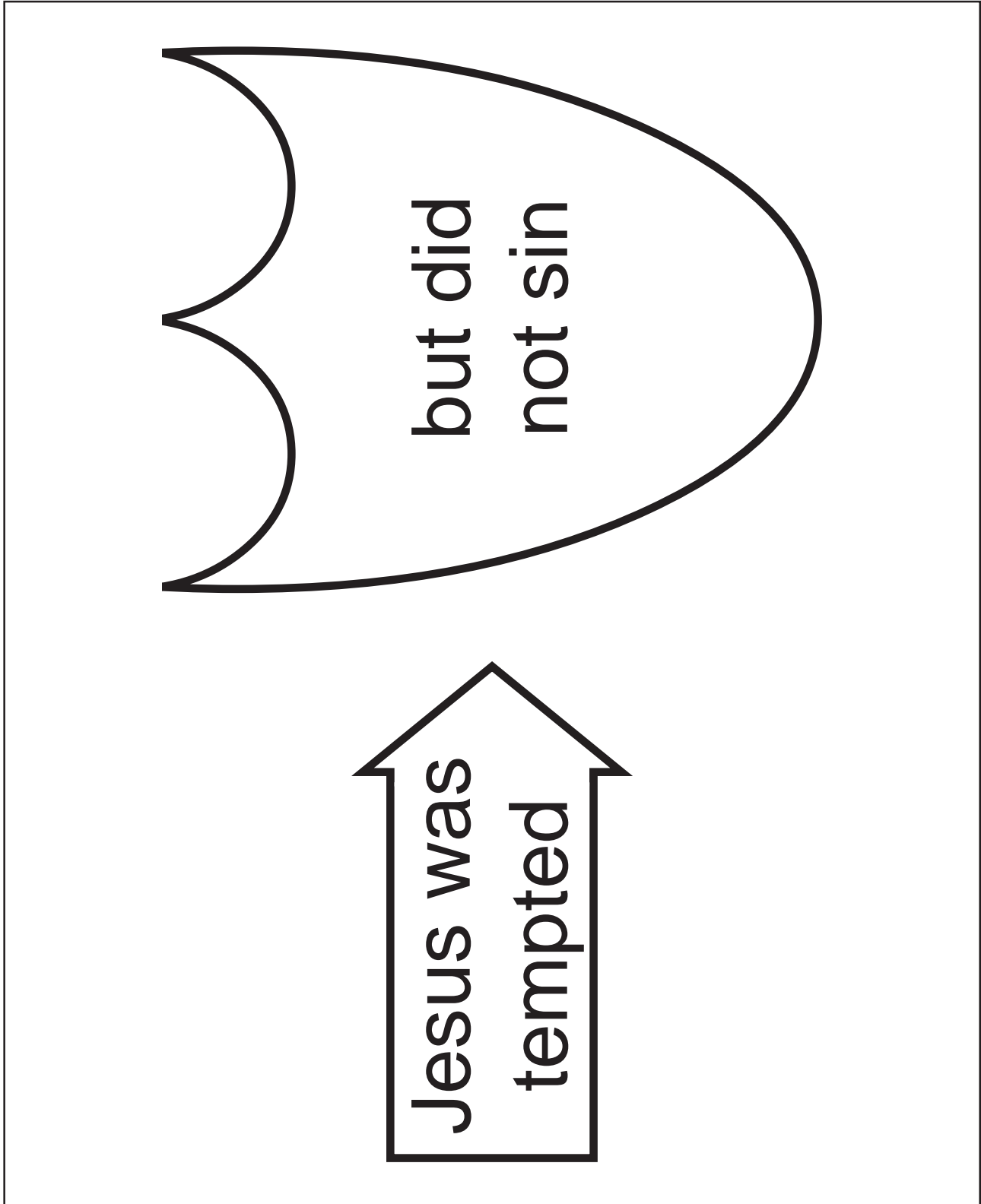

Using God's Word

Carry-over activity - lesson 5

Satan's lies	God's truth
"Lies are not important sins. Go ahead and tell that little lie!"	↑ "Therefore, putting away lying, 'Let each one of you speak truth'" - Ephesians 4:25a
"You are too weak to overcome temptation."	↑ "... He [the Holy Spirit] who is in you is greater than he [Satan] who is in the world" - 1 John 4:4b
"Nobody is looking. Go ahead and do that wrong thing!"	↑ "For He [God] looks to the ends of the earth, and sees under the whole heavens" - Job 28:24
"Jesus is far away up in Heaven and it doesn't matter to Him if you cheat or not. Go ahead!"	↑ "... He [the Lord Jesus] always lives to make intercession [pray] for them" Hebrews 7:25b
"It's smart to disobey your parents!"	↑ "Children, obey your parents in the Lord, for this is right" - Ephesians 6:1
"Take that money!"	↑ "You shall not steal" Exodus 20:15

Satan's lies	God's truth
"Lies are not important sins. Go ahead and tell that little lie!"	↑ "Therefore, putting away lying, 'Let each one of you speak truth'" - Ephesians 4:25a
"You are too weak to overcome temptation."	↑ "... He [the Holy Spirit] who is in you is greater than he [Satan] who is in the world" - 1 John 4:4b
"Nobody is looking. Go ahead and do that wrong thing!"	↑ "For He [God] looks to the ends of the earth, and sees under the whole heavens" - Job 28:24
"Jesus is far away up in Heaven and it doesn't matter to Him if you cheat or not. Go ahead!"	↑ "... He [the Lord Jesus] always lives to make intercession [pray] for them" Hebrews 7:25b
"It's smart to disobey your parents!"	↑ "Children, obey your parents in the Lord, for this is right" - Ephesians 6:1
"Take that money!"	↑ "You shall not steal" Exodus 20:15

Satan's lies	God's truth
"Lies are not important sins. Go ahead and tell that little lie!"	↑ "Therefore, putting away lying, 'Let each one of you speak truth'" - Ephesians 4:25a
"You are too weak to overcome temptation."	↑ "... He [the Holy Spirit] who is in you is greater than he [Satan] who is in the world" - 1 John 4:4b
"Nobody is looking. Go ahead and do that wrong thing!"	↑ "For He [God] looks to the ends of the earth, and sees under the whole heavens" - Job 28:24
"Jesus is far away up in Heaven and it doesn't matter to Him if you cheat or not. Go ahead!"	↑ "... He [the Lord Jesus] always lives to make intercession [pray] for them" Hebrews 7:25b
"It's smart to disobey your parents!"	↑ "Children, obey your parents in the Lord, for this is right" - Ephesians 6:1
"Take that money!"	↑ "You shall not steal" Exodus 20:15

Satan's lies	God's truth
"Lies are not important sins. Go ahead and tell that little lie!"	↑ "Therefore, putting away lying, 'Let each one of you speak truth'" - Ephesians 4:25a
"You are too weak to overcome temptation."	↑ "... He [the Holy Spirit] who is in you is greater than he [Satan] who is in the world" - 1 John 4:4b
"Nobody is looking. Go ahead and do that wrong thing!"	↑ "For He [God] looks to the ends of the earth, and sees under the whole heavens" - Job 28:24
"Jesus is far away up in Heaven and it doesn't matter to Him if you cheat or not. Go ahead!"	↑ "... He [the Lord Jesus] always lives to make intercession [pray] for them" Hebrews 7:25b
"It's smart to disobey your parents!"	↑ "Children, obey your parents in the Lord, for this is right" - Ephesians 6:1
"Take that money!"	↑ "You shall not steal" Exodus 20:15

Following Jesus

Central truth - lesson 6

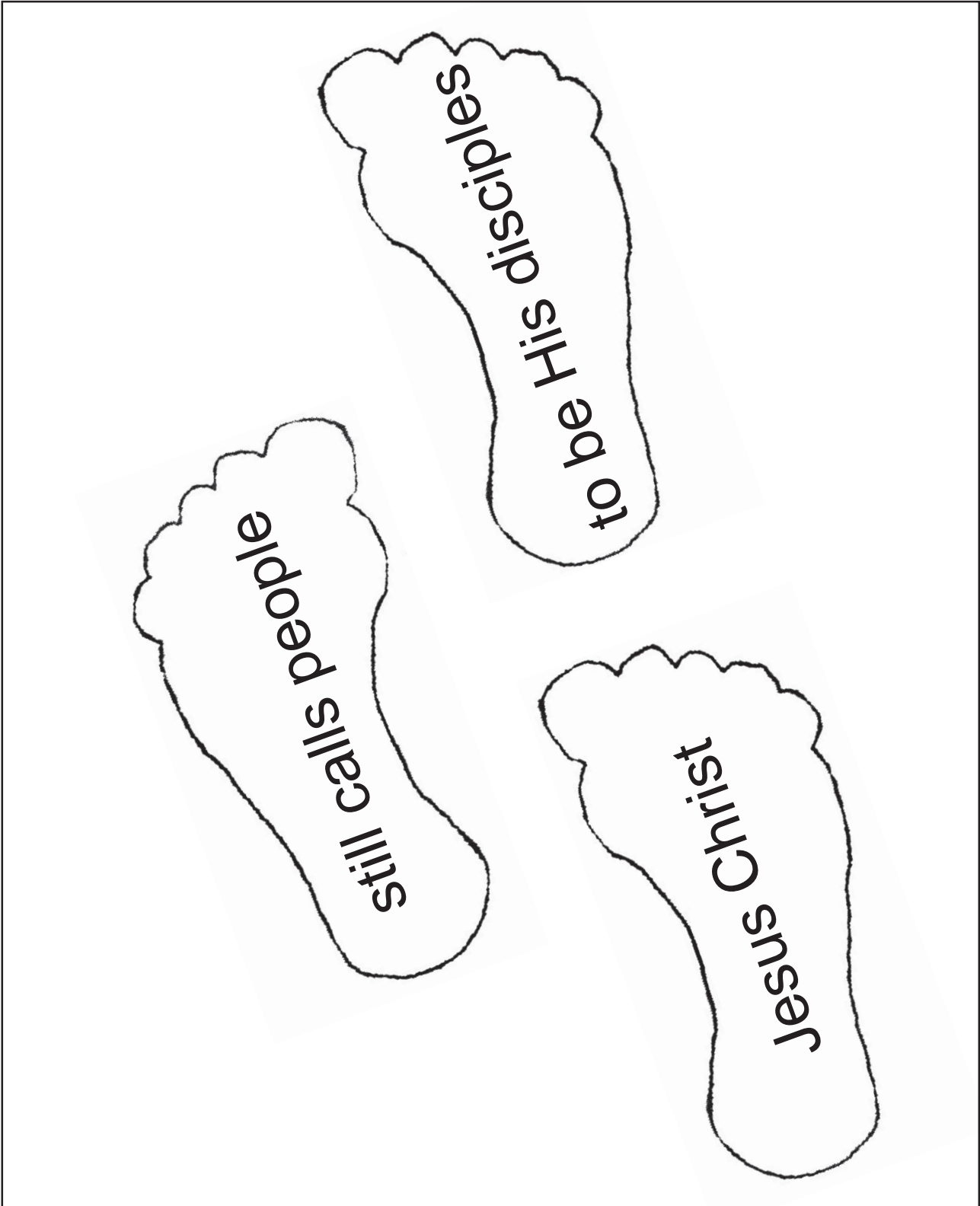

Following Jesus

Carry-over activity - lesson 6

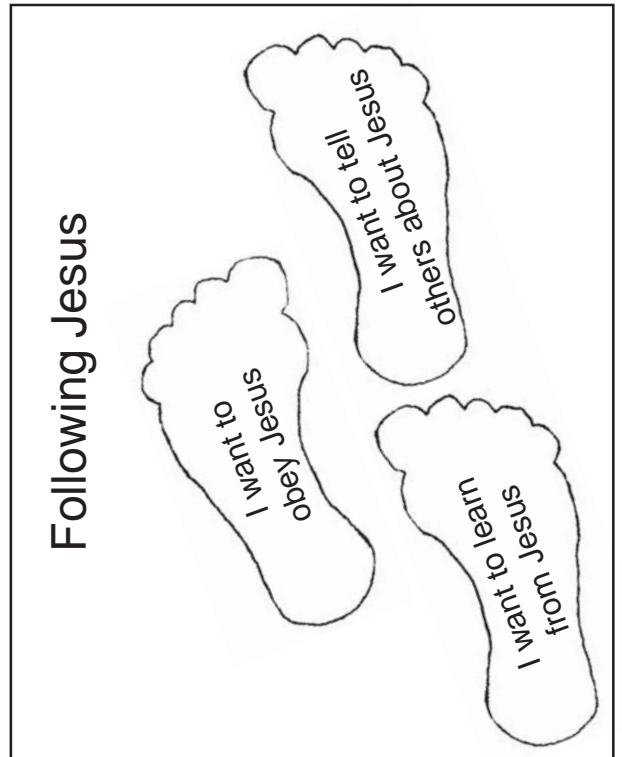
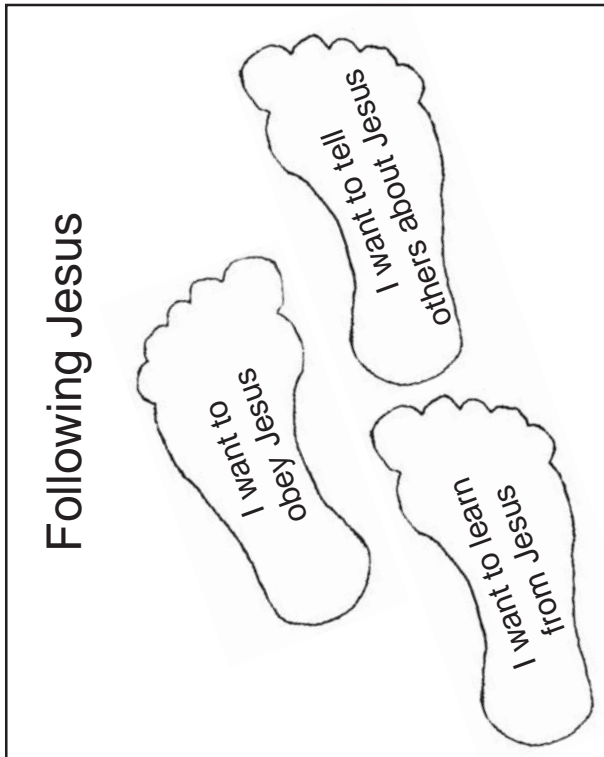
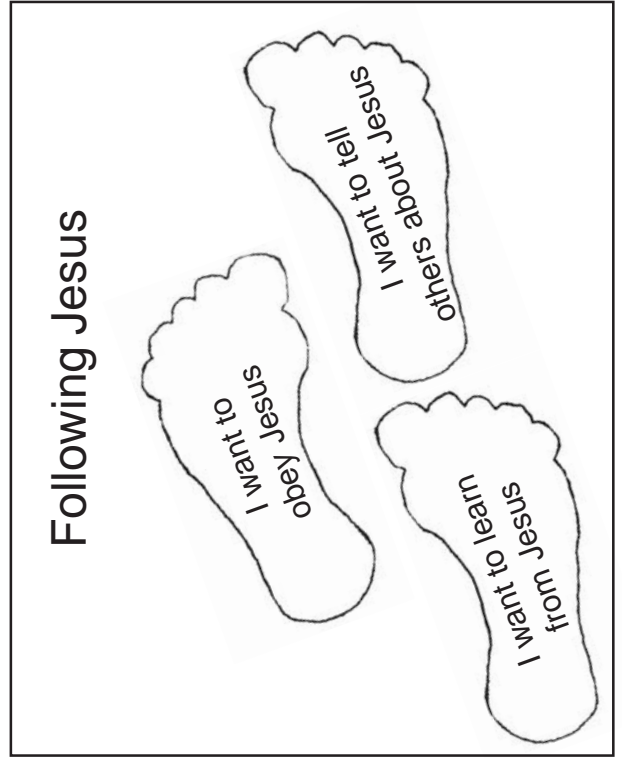
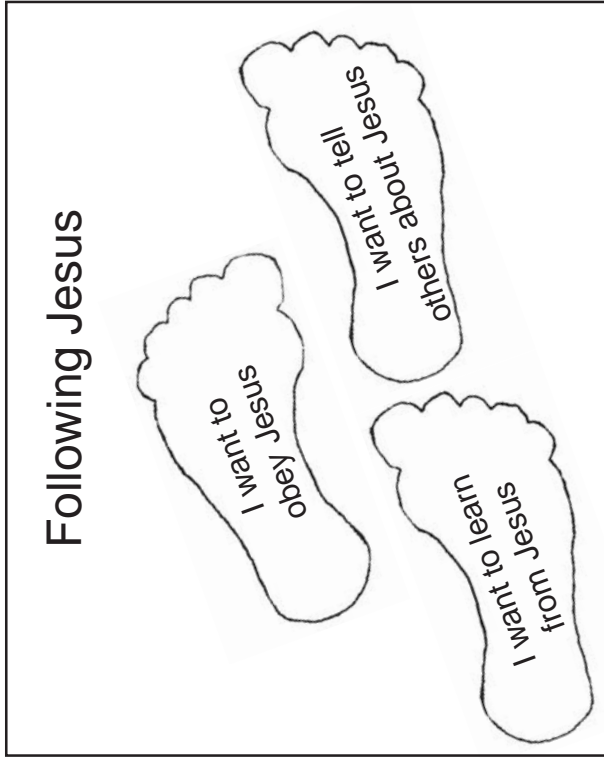

Copy, cut out and keep in your Bible



Summary of steps for counselling the child who wants to come to Christ

Make sure the child understands about

God

Who is God?
God made us. He speaks to us through the Bible.
God is holy and pure. He loves us.

Sin

What is sin?
Sin is disobeying God's commands. It is against God.
Speak about specific sins.
The child is a sinner by nature and act. (We sin because we are sinners.)
Sin deserves punishment.

The Saviour

Who alone can take away your sin?
God the Son died on the cross for sinners.
The Lord Jesus rose again from the dead.
He is Lord of all.

Explain how to be saved

Explain what the Lord wants us to do, and what He will do.
Use a Bible verse (*John 1:12; 3:16; 6:37; Acts 16:31; Romans 6:23 or 10:13*).
What does the Lord want you to do?
What will the Lord do?
Warn about difficulties.
Ask: "Do you want to trust Christ, or would you rather wait?"
Encourage the child to pray audibly (if ready).

Speak about assurance of salvation

Go back to the Bible verse you used.
Speak about a changed life.
Tell him what the person who is truly trusting in Christ can know.

Give (later) some advice about the Christian life

Read and obey your Bible.
Talk to God, our heavenly Father.
Tell others what the Lord has done for you.
Ask God to forgive you when you sin.
Meet with other Christians.
Remember the Lord promises: "*I will never leave you*" (*Heb 13:5*).